

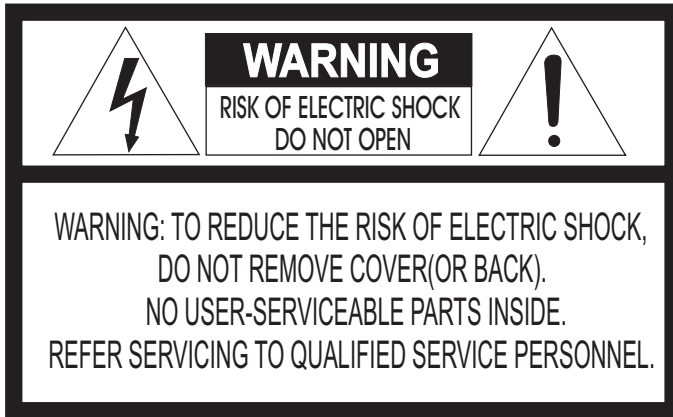



## WARNING:

TO REDUCE THE RISK OF FIRE OR ELECTRIC SHOCK, DO NOT EXPOSE THIS PRODUCT TO RAIN OR MOISTURE.  
DO NOT INSERT ANY METALLIC OBJECT THROUGH VENTILATION GRILLS.



### Explanation of Graphical Symbols



The lightning flash with arrowhead symbol, within an equilateral triangle, is intended to alert the user to the presence of uninsulated "dangerous voltage" within the product's enclosure that may be of sufficient magnitude to constitute a risk of electric shock to persons.



The exclamation point within an equilateral triangle is intended to alert the user to the presence of important operating and maintenance (servicing) instructions in the literature accompanying the product.

## **Safety Precautions**

Should any liquid or solid object fall into the cabinet, unplug the unit and have it checked by qualified personnel before operating it any further.

Unplug the unit from the wall outlet if it is not going to be used for several days or more. To disconnect the cord, pull it out by the plug. Never pull the cord itself.

Allow adequate air circulation to prevent internal heat build-up. Do not place the unit on soft surfaces (rugs, carpets, sofas, etc.) or near materials (curtains, draperies) that may block the ventilation holes.

Height and vertical linearity controls located on the rear panel are for special adjustments by qualified personnel only.

# IMPORTANT SAFEGUARDS

---

1. **READ INSTRUCTIONS** – Read the safety and operating instructions before operating the unit.
2. **RETAIN INSTRUCTIONS** – Retain the safety and operating instructions for future reference.
3. **CLEANING** – Unplug unit from the wall outlet before cleaning. Do not use liquid cleaners or aerosol cleaners. Use a damp cloth for cleaning.
4. **ATTACHMENTS** – Do not use attachments not approved by the manufacturer as they may result in the risk of fire, electric shock or injury.
5. **WATER AND MOISTURE** – Do not use unit near water; for example, near a bathtub, washbowl, kitchen sink, laundry tub, in a wet basement, or near a swimming pool.
6. **ACCESSORIES** – Do not place unit or equipment on an unstable cart, stand or table. The unit or equipment may fall, causing serious injury and serious damage to the equipment. Wall or shelf mounting should follow the manufacturer's instructions, and should use a mounting kit approved by the manufacturer.
7.  **CARTS** – Video equipment and cart combinations should be moved with care. Quick stops, excessive force and uneven surfaces may cause the equipment and cart combination to overturn.
8. **VENTILATION** – Slots and openings in the cabinet and the back or bottom are provided for ventilation, to ensure reliable operation of the video equipment and to protect it from overheating. These openings must not be blocked or covered. The openings should never be blocked by placing the unit on a bed, sofa, rug or other similar surface. The unit should never be placed near or over a radiator or heat register. The unit should not be placed in a built-in installation such as a bookcase unless proper ventilation is provided.
9. **POWER SOURCES** – The unit should be operated only from the type of power source indicated on the marking label. If you are not certain of the type of power supply you have, consult your video equipment dealer or local power company.
10. **GROUNDING OR POLARIZATION** – This unit may be equipped with a polarized alternating-current line plug (a plug with one blade wider than the other). This plug will fit into the power outlet only one way. This is a safety feature. If you are unable to insert the plug fully into the outlet, try reversing the plug. If the plug still fails to fit, contact your electrician to replace your obsolete outlet. Do not defeat the safety purpose of the polarized plug. If your unit is equipped with a three-wire grounding-type plug (a plug having a third grounding pin), this plug will only fit into a grounding-type power outlet. This is a safety feature. If you are unable to insert the plug into the outlet, contact your electrician to replace your obsolete outlet. Do not defeat the safety purpose of the grounding-type plug.

11. **POWER CORDS** – Do not allow anything to rest on the power cord. Do not locate unit or equipment where the cord can be damaged by persons walking on it.
12. **HEED WARNINGS** – Follow all instructions marked on the unit.
13. **LIGHTNING** – During lightning storms or when the unit will be left unattended and unused for long periods, unplug the unit and associated equipment from the wall outlet. This will prevent damage to the video equipment caused by lightning and power-line surges.
14. **OVERLOADING** – Do not overload wall outlets and extension cords as this can result in a risk of fire or electric shock.
15. **OBJECT AND LIQUID ENTRY** – Never push objects of any kind into the unit through openings as they may touch dangerous voltage points or short out parts that could result in a fire or electric shock. Never spill liquid of any kind on the product.
16. **SERVICING** – Do not attempt to service the unit as opening or removing covers may expose you to dangerous voltage or other hazards. Refer all servicing to qualified service personnel.
17. **DAMAGE REQUIRING SERVICE** – Unplug the unit and equipment from the wall outlet and refer servicing to qualified service personnel under the following conditions:
  - A. When the power-supply cord or the plug has been damaged.
  - B. If liquid has spilled, or objects have fallen into the unit.
  - C. If the unit has been exposed to rain or water.
  - D. If the unit does not operate normally when following the operating instructions, adjust only those controls that are covered by the operating instructions as an improper adjustment of other controls may result in damage and will often require extensive work by a qualified technician to restore the unit to its normal operation.
  - E. If the unit has been dropped or the cabinet damaged.
  - F. When the unit exhibits a distinct change in performance, this indicates a need for service.
18. **REPLACEMENT PARTS** – When replacement parts are required, be sure the service technician uses replacement parts specified by the manufacturer or that have the same characteristics as the original part. Unauthorized substitutions may result in fire, electric shock or other hazards.
19. **SAFETY CHECK** – Upon completion of any service or repairs to the unit, ask the service technician to perform safety checks to determine that the video product is in proper operating condition.
20. **FIELD INSTALLATION** – Installation should be performed by a qualified service person and should conform to all local codes.

# FCC COMPLIANCE STATEMENT

---

**FCC INFORMATION :** THIS EQUIPMENT HAS BEEN TESTED AND FOUND TO COMPLY WITH THE LIMITS FOR A CLASS A DIGITAL DEVICE, PURSUANT TO PART 15 OF THE FCC RULES. THESE LIMITS ARE DESIGNED TO PROVIDE REASONABLE PROTECTION AGAINST HARMFUL INTERFERENCE WHEN THE EQUIPMENT IS OPERATED IN A COMMERCIAL ENVIRONMENT. THIS EQUIPMENT GENERATES, USES, AND CAN RADIATE RADIO FREQUENCY ENERGY AND IF NOT INSTALLED AND USED IN ACCORDANCE WITH THE INSTRUCTION MANUAL, MAY CAUSE HARMFUL INTERFERENCE TO RADIO COMMUNICATIONS. OPERATION OF THIS EQUIPMENT IN A RESIDENTIAL AREA IS LIKELY TO CAUSE HARMFUL INTERFERENCE IN WHICH CASE THE USER WILL BE REQUIRED TO CORRECT THE INTERFERENCE AT HIS OWN EXPENSE.

**CAUTION :** CHANGES OR MODIFICATIONS NOT EXPRESSLY APPROVED BY THE PARTY RESPONSIBLE FOR COMPLIANCE COULD VOID THE USER'S AUTHORITY TO OPERATE THE EQUIPMENT.

THIS CLASS A DIGITAL APPARATUS COMPLIES WITH CANADIAN ICES-003.

CEI APPAREIL NUMÉRIQUE DE LA CLASSE A EST CONFORME À LA NORME NMB-003 DU CANADA.

# CE COMPLIANCE STATEMENT

**WARNING :** THIS IS A CLASS A PRODUCT. IN A DOMESTIC ENVIRONMENT THIS PRODUCT MAY CAUSE RADIO INTERFERENCE IN WHICH CASE THE USER MAY BE REQUIRED TO TAKE ADEQUATE MEASURES.

# Table Of Contents Pages

---

<b>Chapter 1 Introduction</b> .....	1
Features .....	1
Technical Overview .....	3
<b>Chapter 2 Installation</b> .....	5
Required Tools .....	5
Connecting Cameras .....	5
Connecting Monitors .....	6
Connecting VCRs .....	6
Connection a Mouse .....	7
Daisy-Chaining and Remote Control Connections .....	7
Alarms and Other Connections .....	8
Initial Setup .....	8
Accessing the Main Menu .....	8
Main Menu Settings .....	10
Time, Date Setup .....	11
Camera Access Setup .....	13
Camera Title Setup .....	14
Camera Sequence Setup .....	15
Alarm Setup .....	16
Alarm I/O Setup .....	18
Alarm Action Setup (1) .....	19
Alarm Action Setup (2) .....	20
Associated Camera Setup .....	22
Motion Action Setup (1) .....	23
Motion Action Setup (2) .....	24
Video Loss Action Setup .....	25
Manual Alarm Action Setup (1) .....	27
Manual Alarm Action Setup (2) .....	29
Macro Link Setup .....	30
Alarm History .....	31
Motion Detection Setup .....	32



Motion Detection Index Setup .....	33
Motion Detection Index List .....	34
Motion Detection Schedule Setup .....	35
Motion Detection Sensor Setup .....	36
Motion Detection Sensor Setup (Normal) .....	38
Testing Motion Detection Sensor Setup .....	39
Motion Detection Sensor Setup (Vector) .....	40
Playback & Recording Setup .....	40
VCR System Setup .....	41
Recording Index Setup .....	42
Camera Picture Adjustment .....	43
Macro Setup .....	45
Macro Record Setup .....	46
Macro Schedule Setup .....	47
Unit Setup .....	48
Password Setup .....	50
Assigning Passwords .....	51
<b>Chapter 3 Operation</b> .....	<b>53</b>
Buttons and Their Functions .....	53
Menu Operation .....	56
Top Menu .....	56
Bottom Menu .....	56
Live Screen .....	57
Pop Up Menu .....	58
Live Camera Change .....	59
VCR Camera Change .....	60
Zoom .....	61
Full .....	62
Priority On .....	62
Histogram Equalizer .....	62
Panic Record On .....	63
Freeze On .....	63
Sequence .....	63
Utilities .....	64

User Scrn Chg...	64
OSD Change...	66
Screen Protect...	67
Manual Alarm...	67
Alarm Reset	67
Spot Output...	68
Macro	68
User Change...	68
Alarm List...	69
Playback Format...	70
PB Picture Adjust...	70
<b>Appendix A Troubleshooting</b>	<b>71</b>
<b>Appendix B Connector Pin Outs</b>	<b>72</b>
<b>Appendix C Remote Control</b>	<b>74</b>
Remote Control for Daisychained Multiplexers	74
Remote Command Set	75
Functional remote commands	76
<b>Appendix D Specifications</b>	<b>77</b>
Operating Defaults	77
Factory Defaults	77
Video Format	80
Video Level	80
Main Output Display Formats (live and playback)	80
Resolution (pixels x lines)	80
Sampling Standard	81
Video Memory	81
Refresh Rate (fields/sec.)	81
Display Options	81
Motion Detection	82
VCR Playback	82
Alarm Operation	82

On-Screen Display (Main) .....	83
On-Screen Display (Spot) .....	83
Other Features (Internal) .....	83
Other Features (External Interface) .....	84
Remote Control .....	84
Rear Panel Connectors .....	84
Front Panel Controls .....	85
Power Requirements .....	85
Power Adapter .....	85
Dimensions .....	86
Weight .....	86
Operating Environment .....	86

## List of Illustrations

---

Figure 1 — Typical multiplexer system configuration .....	1
Figure 2 — multiplexer connections .....	5
Figure 3 — Connecting one VCR to the multiplexer .....	6
Figure 4 — Connecting two VCRs to the multiplexer .....	7
Figure 5 — Top menu bar .....	8
Figure 6 — Supervisor Password screen .....	9
Figure 7 — Main Menu screen .....	10
Figure 8 — Time, Date Setup, first screen .....	10
Figure 9 — Time, Date Setup, second screen .....	12
Figure 10 — Camera Access Setup screen .....	13
Figure 11 — Camera Title Setup screen .....	14
Figure 12 — Camera Sequence Setup screen .....	15
Figure 13 — Alarm Setup screen .....	16
Figure 14 — Alarm I/O Setup screen .....	18
Figure 15 — Alarm Action Setup (1) screen .....	19
Figure 16 — Alarm Action Setup (2) screen .....	20
Figure 17 — Associated Camera Setup submenu .....	22
Figure 18 — Motion Action Setup (1) screen .....	23
Figure 19 — Motion Action Setup (2) screen .....	24
Figure 20 — Video Loss Action Setup screen .....	25
Figure 21 — Manual Alarm Action Setup (1) screen .....	27
Figure 22 — Manual Alarm Action Setup (2) screen .....	29
Figure 23 — Macro Link Setup screen .....	30
Figure 24 — Alarm History List screen .....	31
Figure 25 — Motion Detection Setup screen .....	32
Figure 26 — Motion Detection Index Setup screen .....	33
Figure 27 — Motion Detection Index List screen .....	34
Figure 28 — Motion Detection Schedule Setup schedule.....	35
Figure 29 — Motion Detection Sensor Setup screen .....	36
Figure 30 — Motion Detection Sensor Setup (Normal) screen .....	38
Figure 31 — Motion Detection Sensor Setup test screen .....	39
Figure 32 — Playback & Recording Setup screen.....	40

Figure 33 — VCR System Setup screen .....	41
Figure 34 — Recording Index Setup screen.....	42
Figure 35 — Camera Picture Adjustment screen.....	43
Figure 36 — Macro Setup screen.....	45
Figure 37 — Macro Record Setup screen.....	46
Figure 38 — Live screen with M01 REC on the screen.....	47
Figure 39 — Macro Schedule Setup screen.....	47
Figure 40 — Unit Setup screen.....	48
Figure 41 — Passwords Setup screen.....	50
Figure 42 — Password entry screen.....	51
Figure 43 — Front Panel.....	53
Figure 44 — Top Menu.....	56
Figure 45 — Bottom Menu.....	56
Figure 46 — 4x4 Live Screen.....	57
Figure 47 — Pop Up menu.....	58
Figure 48 — Live Cam Change menu.....	59
Figure 49 — VCR Cam Change menu.....	60
Figure 50 — Zoom Screen.....	61
Figure 51 — Histogram Equalizer menu bar.....	62
Figure 52 — Sequence menu.....	63
Figure 53 — Utilities Pop Up menu.....	64
Figure 54 — User Screen Change menu bar.....	64
Figure 55 — Select a Screen menu.....	65
Figure 56 — OSD Setup screen.....	66
Figure 57 — Spot output change screen.....	68
Figure 58 — User Change menu.....	68
Figure 59 — Alarm History List.....	69
Figure 60 — Select Format menu.....	70
Figure 61 — Connetor Sub-Board.....	72
Figure 62 — RS-485 Connector.....	73
Table 1 — Re-Address Commands.....	74
Table 2 — Front key emulation commands.....	75
Table 3 — Remote commands.....	76



# Chapter 1 Introduction

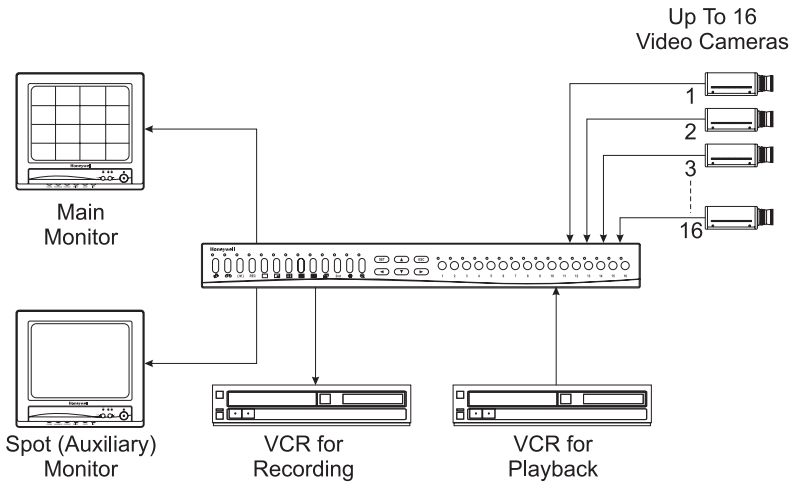

< Figure 1 > Typical multiplexer system configuration.

## Features

- Compatible with standard color cameras and other standard video sources
- Switchable between NTSC and PAL
- Able to decode tapes from many other brands of multiplexers
- Many user-selectable display formats, Cameras can be assigned to any display format
- Multiple monitor outputs (1 Main, 4 Auxiliary) allow simultaneous multi-camera and full-screen viewing
- Multilingual setup menus include English, French, Italian, German, Polish and Spanish
- On-screen display includes date, time, alarm status, video loss, camera number and 24-character camera titles
- Programmable day and night motion-detection schedules

- Each camera has a programmable 256-target (16 x 16) motion-detection grid
- Programmable vector-based motion detection in any direction
- Nonvolatile program memory saves all user settings and protects them against power outages
- One TTL/CMOS contact closure alarm for each camera
- Up to 4 cameras can be associated with a single contact closure alarm
- Alarm input polarity is user selectable
- VCR switch pulse input for synchronization with VCRs having switch pulse feature
- Full triplex operation allows simultaneous recording, playback and live viewing
- 256-event alarm history log
- Linear Zoom in and out up to 32 times



## Technical Overview

---

### 16 Camera Multiplexing with Motion Detection, Alarm Association and Multilingual Setup Menus

The multiplexer has revolutionary features not available in most multiplexers. The multiplexer has a sophisticated motion detection system that can sense motion vectors in any direction. Motion detection sensitivity can be adjusted and the user can set day and night motion detection schedules. A motion tracking box gives visual indications for easy setup.

The multiplexer has both composite BNC and Y/C mini DIN inputs and outputs for VCRs. The main monitor can be connected to either a composite BNC or Y/C mini DIN output. There are four BNC auxiliary outputs that can be used for “spot” monitors or as sources of video for other devices.

The multiplexer has a large selection of user selectable display formats. It also has digital zooming from 1 to 32 times.

The multiplexer multilingual menu options allow for easy setup. The user’s configuration is stored in nonvolatile memory so that it will not be lost during power outages.

The multiplexer can play back videotapes recorded with many other multiplexers. These include, but are not limited to; HONEYWELL; DAVE; ULTRAK Legacy Color; ULTRAK Legacy B/W; DM; ROBOT; KALATEL. Up to 16 multiplexers can be “daisy chained” and addressed and controlled by a single control panel. The multiplexer can also be addressed by a computer using either an RS-232 or RS-485 connection.



# Chapter 2 Installation

## Required Tools

Although no special tools are required to install the multiplexer, it is only one part of a complex system. Refer to the Installation manuals for the other components in your particular installation for special tool requirements.

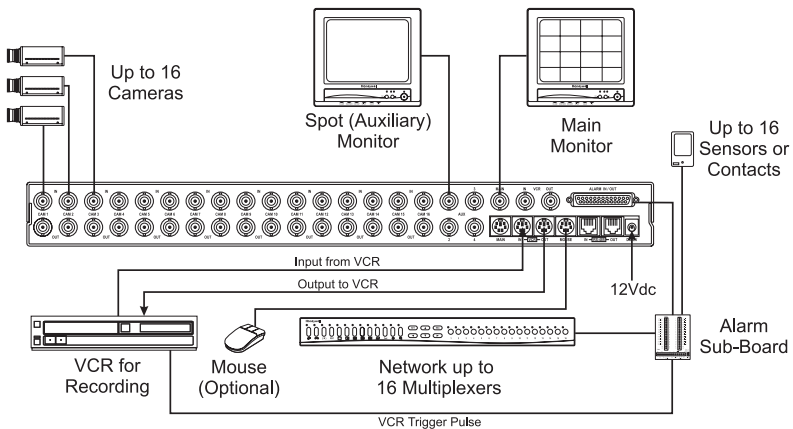

< Figure 2 > multiplexer connections.

## Connecting Cameras

You can connect up to 16 cameras to the multiplexer. Connect the camera BNCs to the IN BNC connectors (top row). The loop-through connectors (OUT) are auto-terminated, so terminating resistors are not needed if you do not loop video out to another device.

**NOTE :** *Connecting a cable to the loop-through connector switches off the termination. Do NOT connect a cable to the loop-through BNC connectors unless it is connected to the input of another video device.*

## Connecting Monitors

---

Your main monitor should be connected to the MAIN output. There are two MAIN connectors; an S-Video and a BNC. If your monitor has an S-Video input, you should use the S-Video MAIN.

Up to four auxiliary monitors can be connected to the multiplexer. You can use these as spot monitors or to view live video while playing tapes back through the main monitor. The auxiliary monitors should be connected to the AUX BNC connectors.

## Connecting VCRs

---

There are both BNC and S-Video connectors for the VCRs. Use the S-Video connectors if your VCR has them because they will give you better quality video.

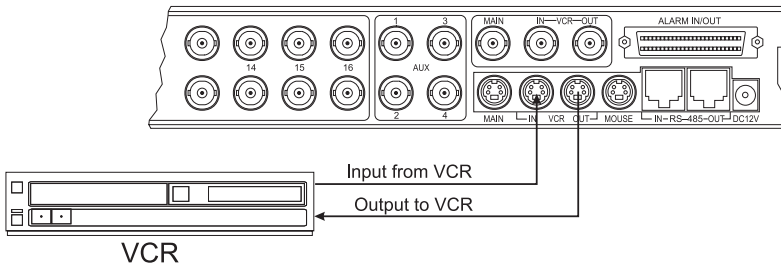

< Figure 3 > Connecting one VCR to the multiplexer.

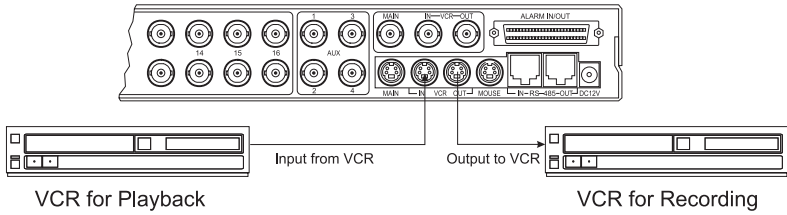

< Figure 4 > Connecting two VCRs to the multiplexer.

You can connect one VCR to the multiplexer and use it for both recording and playback. However, the multiplexer can handle recording and playback at the same time, so it is possible to connect two VCRs. One VCR is used to record while the other is used to play back. (See the illustrations.)

## Connecting a Mouse

The multiplexer menus can be controlled by either buttons on the front panel or by a mouse. If you plan to use a mouse, connect it to the mini-DIN connector labeled MOUSE.

The multiplexer is not compatible with all mouse available in the market. Please note that users are recommended to use "Recommended mouse" only described in the manual. Logitech mouse (Ball mouse only)

**NOTE :** *Compatible mouse can be added without prior notice for better performance.*

## Daisy-Chaining and Remote Control Connections

The multiplexer can be daisy-chained to other multiplexers or controlled by a remote keyboard. To add another multiplexer to your system, connect the RS-485 OUT connector of the additional unit to the IN RS-485 connector. (See Setup Menu section to set multiplexer address.)

The remote keyboard should be connected to the OUT connector on the multiplexer.

## Alarms and Other Connections

---

The 50-pin ALARM IN/OUT connector has 16 alarm inputs, 16 alarm outputs, RS-232 connectors, VCR trigger pulse and various alarm settings. See Appendix B — Connector Pin Outs for further details on how to make these connections.

## Initial Setup

---

Setting up for NTSC or PAL Operation



**NOTE :** *When changing the multiplexer to NTSC or PAL all other settings are returned to the factory defaults.*

The multiplexer can be used with either NTSC or PAL systems.

To set it up for NTSC operation:

- 1) Turn off the power
- 2) Press and hold the  and {M} buttons.
- 3) Turn on the power

To set up the multiplexer for PAL operation:

- 1) Turn off the power
- 2) Press and hold the  and  buttons.
- 3) Turn on the power

## Accessing the Main Menu

---

**NOTE :** *To access the Main Menu you must have a Supervisor Password. The last item of the Main Menu is the Password Setup. Keep the passwords you create in a safe place. The new passwords will be the only way to access certain features of the multiplexer once you have changed from the factory default passwords.*



< Figure 5 > Top menu bar.

To access the Main Menu of the setup screens, move the cursor to the top of the screen. The top menu bar appears. Select Setup.

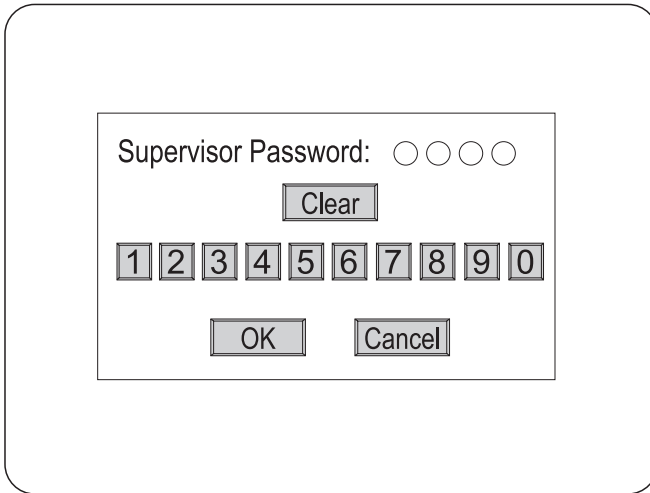

< Figure 6 > Supervisor Password screen.

Enter the password by moving the cursor over the desired number and clicking on it. As you enter each digit, the circles beside "Supervisor Password" fill in and move to the right. Once you have entered all four digits, click on OK. If you have entered the correct four-digit number, the Main Menu will appear. If you have entered an incorrect number, Incorrect Password displays for ten seconds then the unit returns to a live display.

The factory default passwords are listed in the Technical Specifications.

Click on Cancel to exit the Supervisor Password screen and return to live display.

# Main Menu Settings

---

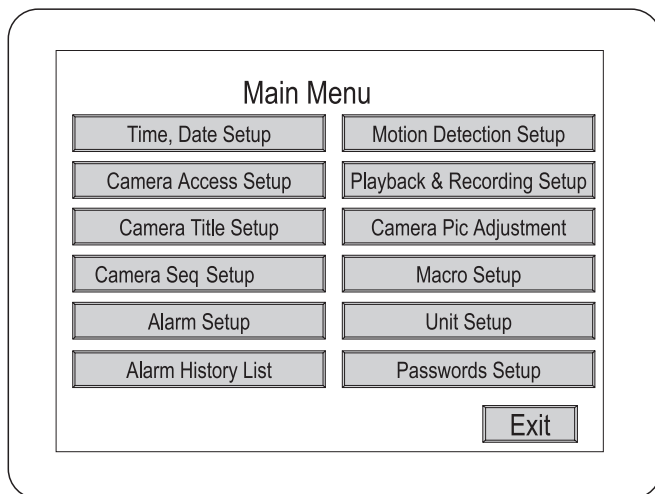

< Figure 7 > Main Menu screen.

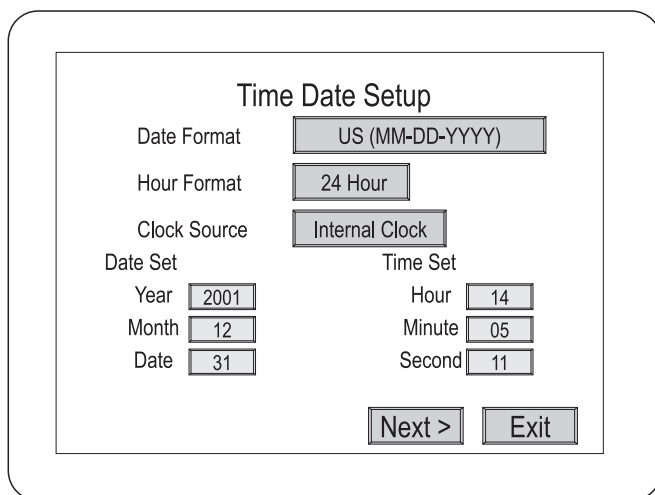

< Figure 8 > Time, Date Setup, first screen.



## Time, Date Setup

---

In addition to setting the multiplexer's time and date, these screens can be used to set the format and select daylight saving time. You can use the arrow buttons on the multiplexer or mouse to select the menu item. Press SET or the left mouse button to decrease the number. Press ESC or the right mouse button to increase the number.

- **Date format** : There are three date formats to choose from. The month and days are each two-digit numbers represented by MM and DD. Years are four-digit numbers represented by YYYY. The U.S. format is: MM-DD-YYYY. Europe's format is: DD-MM-YYYY. Asia's format is: YYYY-MM-DD.
- **Hour format** : There are two hour formats to choose from. One is 24-hour (military) time. The second is AM/PM.
- **Clock Source** : There are two choices for the clock source. If your multiplexer is connected to a network, set the option to Network Clock and the unit will receive the clock information from the master multiplexer. If your multiplexer is not connected to a network, set the option to Internal Clock.
- **Year** : Use the arrow or mouse buttons to change the year.
- **Month** : Use the arrow or mouse buttons to change the month.
- **Date** : Use the arrow or mouse buttons to change the date.
- **Hour** : Use the arrow or mouse buttons to change the hour.
- **Minute** : Use the arrow or mouse buttons to change the minute.
- **Second** : Use the arrow or mouse buttons to change the second.
- **Next >** : Selecting this takes you to the second Daylight Saving setup Screen.

**Daylight Saving Setup**

Daylight Saving

Start		Stop	
Month	04	Month	10
Date	01	Date	01
From	02 : 00	From	03 : 00
To	03 : 00	To	02 : 00

**< Figure 9 >** Time, Date Setup, second screen.

- **Daylight Saving** : If you are in an area that does not have Daylight Saving (Summer) Time, set this option to Off. When you set this selection to On, you must set the start and stop dates and times.
- **Start** : Set the Month and Date that your area begins Daylight Saving time. Unless there is an unusual situation, you will not need to set From and To times.
- **Stop** : Set the Month and Date that your area ends Daylight Saving time. Unless there is there is an unusual situation, you will not need to set From and To times.
- **< Back** : Selecting this takes you back to the first Time, Date Setup Screen.
- **Exit** : Selecting this saves your settings and exits the Time, Date Setup screens.

## Camera Access Setup

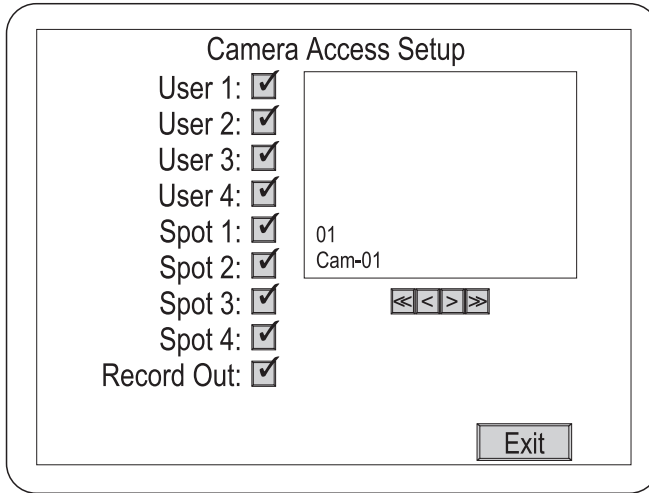

< Figure 10 > Camera Access Setup screen.

The Camera Access Setup screen allows you to assign which cameras different users will have access to and which cameras can be displayed on the Spot (auxiliary) monitors. You can also designate whether a camera can be recorded.

- << : Goes to Camera 1
- < : Goes back one camera
- > : Goes forward one camera.
- >> : Goes to Camera 16
- ✓ : An ✓ next to an item activates the camera for that output.
- ○ : An ○ deactivates the camera.
- **Exit** : Saves your changes and returns to the Main Menu.

## Camera Title Setup

---

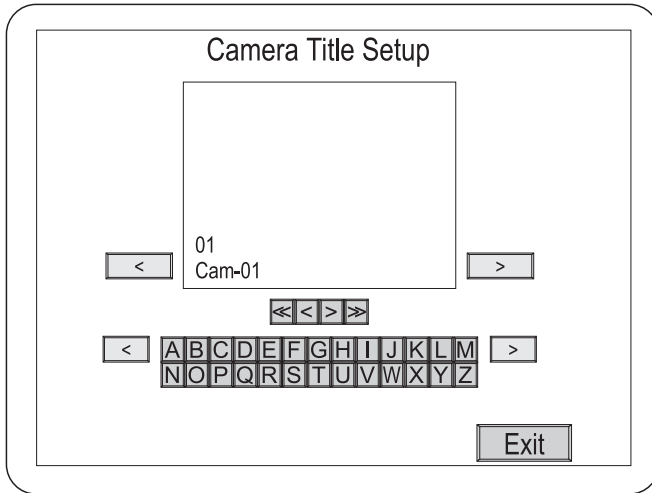

< Figure 11 > Camera Title Setup screen.

The Camera Title Setup screen allows you to enter titles for each camera. Clicking on the letters and characters enters them in the camera title. Each camera title can have a maximum of 24 characters.

- **Top <** : Moves the cursor left.
- **Top >** : Moves the cursor right.
- **Middle <<** : Goes to Camera 1.
- **Middle <** : Goes back one camera.
- **Middle >** : Goes forward one camera.
- **Middle >>** : Goes to Camera 16.
- **Bottom <** : Changes the keyboard characters to the previous set.
- **Bottom >** : Changes the keyboard characters to the next set.

- **Keyboard Character Set 1** : A to Z (upper case)
- **Keyboard Character Set 2** : a to z (lower case)
- **Keyboard Character Set 3** : BLANK ! " # \$ % & ' ( ) \* + , - . / 0 to 9
- **Keyboard Character Set 4** : ; : < = > ? [ \ ] ^ \_ ' { | } ~
- **Keyboard Character Set 5** : À Á Â Ã Ç È É Ê Ë Ì Í Î Ñ Ò Ó Ô Õ Ù Ú Û Ü ß à á â
- **Keyboard Character Set 6** : ä ç è é ê ë ì í î ñ ò ó ô õ ù ú ü
- **Exit** : Saves your changes and returns to the Main Menu.

## Camera Sequence Setup

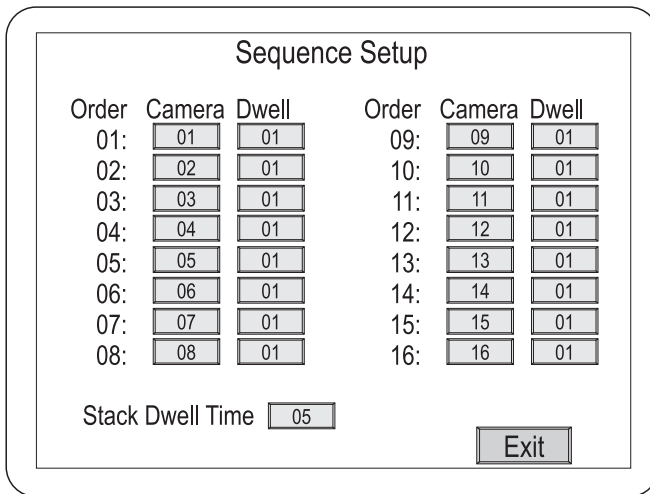

< Figure 12 > Camera Sequence Setup screen.

This screen allows you to set the order in which the cameras appear when the multiplexer is in sequence mode. You can also set the how long each camera will display from Off to 99 seconds.

Enter the camera number under the Camera column and the display time under Dwell. You can also set the Stack Dwell Time, which is the length of time each group of cameras will display.

- **Exit** : Saves your changes and returns to the Main Menu.

## Alarm Setup

---

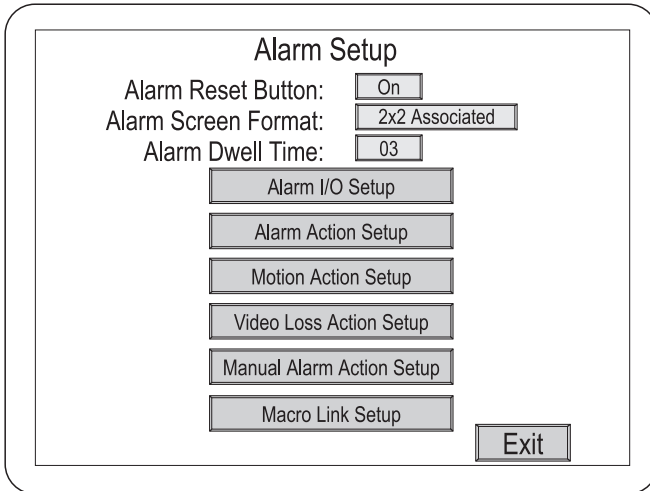

< Figure 13 > Alarm Setup screen.

The Alarm Setup screen allows you to enter six alarm submenus.

- **Alarm Reset Button** : Setting this to On allows users to clear alarm events using the front panel buttons or the Pop Up menu. Setting it to Off requires the user to enter the Setup Menus to clear alarm events.
- **Alarm Screen Format** : This sets the display mode the multiplexer will use when an alarm occurs. There are five possible settings: Full, 2x2, 2x2 Associated, 4x4 and Unchanged.

- **Alarm Dwell Time** : The dwell time can be set from 1 to 99 seconds. (The screen will automatically sequence in a multi-alarm condition.)
- **Alarm I/O Setup** : Enters the Alarm I/O Setup submenu.
- **Alarm Action Setup** : Enters the Alarm Action Setup submenu.
- **Motion Action Setup** : Enters the Motion Action Setup submenu.
- **Video Loss Action Setup** : Enters the Video Loss Action submenu.
- **Manual Alarm Action Setup** : Enters the Manual Alarm Action Setup submenu.
- **Macro Link Setup** : Enters the Macro Link Setup submenu.
- **Exit** : Saves your changes and returns to the Main Menu.

## Alarm I/O Setup

---

The screenshot shows a window titled "Alarm I/O Setup" containing a table of 16 channels. Each channel has two columns: "In" and "Out". The "In" column contains the value "NO" for all channels. The "Out" column contains the value "AH" for all channels. At the bottom right of the window is an "Exit" button.

	In	Out		In	Out
01	NO	AH	09	NO	AH
02	NO	AH	10	NO	AH
03	NO	AH	11	NO	AH
04	NO	AH	12	NO	AH
05	NO	AH	13	NO	AH
06	NO	AH	14	NO	AH
07	NO	AH	15	NO	AH
08	NO	AH	16	NO	AH

Exit

< Figure 14 > Alarm I/O Setup screen.

You can set the input and output for each of the alarm connections.

- **In** : Can be set to NO (Normally Open), NC (Normally Closed) or Off.
- **Out** : Can be set to AH (Active High) or AL (Active Low) TTL output.
- **Exit** : Saves your changes and returns to the Main Menu.



## Alarm Action Setup (1)

---

Alarm Action Setup (1)

Buzzer	<input type="button" value="On"/>	Spot Monitor 1	<input type="button" value="On"/>
Alarm Screen	<input type="button" value="On"/>	Spot Monitor 2	<input type="button" value="On"/>
Network Relay	<input type="button" value="On"/>	Spot Monitor 3	<input type="button" value="On"/>
Message Latch	<input type="button" value="On"/>	Spot Monitor 4	<input type="button" value="On"/>
Recording	<input type="button" value="INT"/>	Hold Time	<input type="button" value="05"/>

< Figure 15 > Alarm Action Setup (1) screen.

This screen allows you to set up the actions the multiplexer will take when there is an alarm condition.

- **Buzzer** : When set to On, the multiplexer's internal buzzer will sound during an alarm condition.
- **Alarm Screen** : When set to On, the screen display will change to the one defined in the Alarm Screen Format menu during an alarm condition.
- **Network Relay** : When set to On, the multiplexer sends the alarm information to an external relay box via the network during an alarm condition.
- **Message Latch** : When set to On, an "A" displays on the screen when an alarm condition occurs. It remains on the screen until it is cleared.

- **Recording** : This allows you to select how video will record during an alarm condition. INT interleaves images from the camera with an alarm every other field giving you more images from that camera. When there are multiple alarms, the cameras with alarms are interleaved.  
ONLY records images from only the camera with an alarm condition.  
UNC leaves the recording parameters unchanged.
- **Spot Monitor 1 to 4** : When set to On, that Spot Monitor will display the camera with an alarm condition. When there are multiple alarms, cameras with alarms will display sequentially. When set to Off, that Spot Monitor's display does not change during alarm conditions.
- **Hold Time** : This allows the user to set the alarm actions to last from 1 to 99 seconds. Hold Time is applicable only if the alarm action is set to Timed OUT.
- **Next >** : This takes you to the Alarm Action Setup (2) submenu.
- **Exit** : Saves your changes and returns to the Main Menu.

## Alarm Action Setup (2)

---

### Alarm Action Setup (2)

	Action	Relay	Associated		Action	Relay	Associated
01	Timed	1	01-02-03-04	09	Timed	1	09-10-11-12
02	Latched	2	02-03-04-05	10	Timed	2	10-11-12-13
03	Timed	1&2	03-04-05-06	11	Timed	1&2	11-12-13-14
04	Timed	Off	04-05-06-07	12	Timed	Off	12-13-14-15
05	Trans	1	05-06-07-08	13	Timed	1	13-14-15-16
06	Timed	1	06-07-08-09	14	Timed	1	14-14-15-16
07	Timed	1	07-08-09-10	15	Timed	1	15-14-15-16
08	Timed	1	08-09-10-11	16	Timed	1	16-14-15-16

< Back
Exit

< Figure 16 > Alarm Action Setup (2) screen.

This screen allows you to set the actions the operator can take, what relays will be activated and what cameras are associated with other cameras.

- **Action** : There are three possible settings. Timed: The alarm will “time out” at the designated time (Hold Time) unless the operator clears it earlier. Latched: The alarm remains active until the operator acknowledges it. Trans (Transparent): The alarms are not latched and cannot be cleared by the operator.
- **Relay** : There are four possible relay settings. 1 or 2: Sets either internal relay 1 or 2 to be activated by an alarm. 1&2: Sets both internal relays 1 and 2 to be activated by an alarm. Off: Neither internal relay will be activated by an alarm.
- **Associated** : This button allows you to associate other cameras with a camera that is in an alarm condition. Selecting this item will take you to the Associated Camera Setup submenu.
- **< Back** : This takes you to the Alarm Action Setup (1) submenu.
- **Exit** : Saves your changes and returns to the Main Menu.

## Associated Camera Setup

---

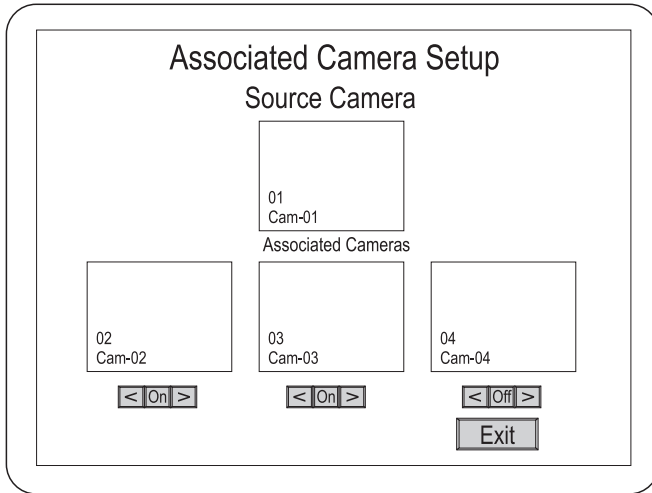

< Figure 17 > Associated Camera Setup submenu.

This menu allows you to associate up to three cameras with another when an alarm condition occurs. The main camera is displayed in the top window with the three associated cameras shown below. Under each of the associated camera windows is a control bar.

- < : Goes through the cameras in reverse order.
- **On/Off** : By setting this to On, the selected camera will be associated with the camera with the alarm condition. (If all three Associated Cameras are set to Off, no cameras will be associated to the camera with that camera.)
- > : Goes through the cameras in forward order.
- **Exit** : Saves your changes and returns to the previous menu.

## Motion Action Setup (1)

---

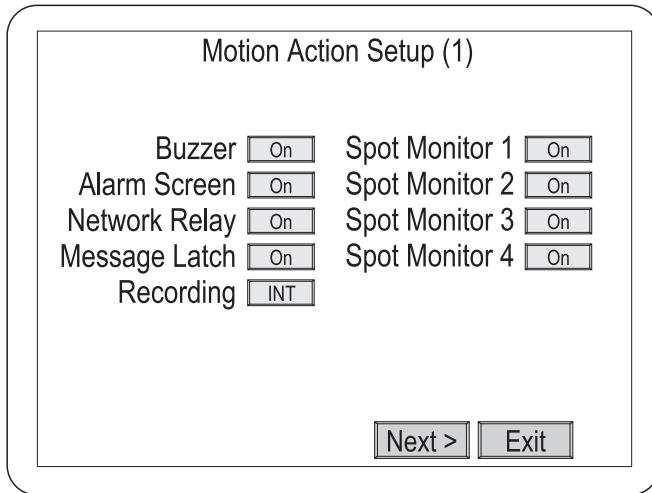

< Figure 18 > Motion Action Setup (1) screen.

This screen allows you to set up the actions the multiplexer will take when there is a motion alarm condition.

- **Buzzer** : When set to On, the multiplexer's internal buzzer will sound during a motion alarm condition.
- **Alarm Screen** : When set to On, the screen display will change to the one defined in the Alarm Screen Format menu during a motion alarm condition.
- **Network Relay** : When set to On, the multiplexer sends the alarm information to an external relay box via the network during a motion alarm condition.
- **Message Latch** : When set to On, an "M" displays on the screen when a motion alarm condition occurs. It remains on the screen until it is cleared.

- **Recording** : This allows you to select how video will record during a motion alarm condition. INT interleaves images from the camera with an alarm every other field giving you more images from that camera. When there are multiple alarms, the cameras with alarms are interleaved. ONLY records images from only the camera with an alarm condition. UNC leaves the recording parameters unchanged.
- **Spot Monitor 1 to 4** : When set to On, that Spot Monitor will display the camera with a motion alarm condition. When there are multiple alarms, cameras with alarms will display sequentially. When set to Off, that Spot Monitor's display does not change during motion alarm conditions.
- **Next >** : This takes you to the Motion Alarm Action Setup (2) submenu.
- **Exit** : Saves your changes and returns to the Main Menu.

## Motion Action Setup (2)

---

**Motion Action Setup (2)**

Relay A.Link		Relay A.Link			
01	1	01	09	1	09
02	2	02	10	2	10
03	1&2	03	11	1&2	11
04	Off	04	12	Off	12
05	1	05	13	1	13
06	1	06	14	1	14
07	1	07	15	1	15
08	1	08	16	1	16

Exit

< Figure 19 > Motion Action Setup (2) screen.

This screen allows you to associate various relays and links to the cameras in motion alarm conditions.

- **Relay** : There are four possible relay settings. 1 or 2: Sets either internal relay 1 or 2 to be activated by a motion alarm. 1&2: Sets both internal relays 1 and 2 to be activated by a motion alarm. Off: Neither internal relay will be activated by a motion alarm.
- **Alarm Link** : This button links the motion detection to an alarm action. It can be set to Off or any one of the 16 alarm actions. All alarm actions take priority over motion actions.
- **< Back** : This takes you to the Motion Alarm Action Setup (1) submenu.
- **Exit** : Saves your changes and returns to the Main Menu.

## Video Loss Action Setup

---

Video Loss Action Setup

Buzzer <input type="button" value="On"/>	Spot Monitor 1 <input type="button" value="On"/>
Alarm Screen <input type="button" value="On"/>	Spot Monitor 2 <input type="button" value="On"/>
Internal Relay <input type="button" value="1"/>	Spot Monitor 3 <input type="button" value="On"/>
Network Relay <input type="button" value="On"/>	Spot Monitor 4 <input type="button" value="On"/>
Message Latch <input type="button" value="On"/>	Hold Time <input type="button" value="05"/>

< Figure 20 > Video Loss Action Setup screen.

This screen allows you to set up the actions the multiplexer will take when there is a video loss condition.

- **Buzzer** : When set to On, the multiplexer's internal buzzer will sound during a video loss condition.
- **Alarm Screen** : When set to On, the screen display will change to the one defined in the Alarm Screen Format menu during a video loss condition.
- **Internal Relay** : Selects which internal relays will be activated during a video loss condition. 1 or 2 activates the designated relay. 1&2 activates both internal relays. Off means neither relay will activate.
- **Network Relay** : When set to On, the multiplexer sends the video loss information to an external relay box via the network during a video loss condition.
- **Message Latch** : When set to On, a "V" displays on the screen when a video loss condition occurs. It remains on the screen until it is cleared.
- **Spot Monitor 1 to 4** : When set to On, that Spot Monitor will display the camera with a video loss condition. When there are multiple alarms, cameras with alarms will display sequentially. When set to Off, that Spot Monitor's display does not change during video loss conditions.
- **Hold Time** : This allows the user to set the actions to last from 1 to 99 seconds.
- **Exit** : Saves your changes and returns to the previous menu.



## Manual Alarm Action Setup (1)

Manual Alarm Action Setup (1)

Buzzer	<input type="text" value="On"/>	Spot Monitor 1	<input type="text" value="On"/>
Alarm Screen	<input type="text" value="On"/>	Spot Monitor 2	<input type="text" value="On"/>
Network Relay	<input type="text" value="On"/>	Spot Monitor 3	<input type="text" value="On"/>
Message Latch	<input type="text" value="On"/>	Spot Monitor 4	<input type="text" value="On"/>
Recording	<input type="text" value="INT"/>	Hold Time	<input type="text" value="05"/>

< Figure 21 > Manual Alarm Action Setup (1) screen.

This screen allows you to set up the actions the multiplexer will take when there is a Manual alarm condition.

- **Buzzer** : When set to On, the multiplexer's internal buzzer will sound during a Manual alarm condition.
- **Alarm Screen** : When set to On, the screen display will change to the one defined in the Alarm Screen Format menu during a Manual alarm condition.
- **Network Relay** : When set to On, the multiplexer sends the alarm information to an external relay box via the network during a Manual alarm condition.
- **Message Latch** : When set to On, an "A" displays on the screen when a Manual alarm condition occurs. It remains on the screen until it is cleared.

- **Recording** : This allows you to select how video will record during a Manual alarm condition. INT interleaves images from camera with an alarm every other field giving you more images from that camera. When there are multiple alarms, the cameras with alarms are interleaved. ONLY records images from only the camera with an alarm condition. UNC leaves the recording parameters unchanged.
- **Spot Monitor 1 to 4** : When set to On, that Spot Monitor will display the camera with a Manual alarm condition. When there are multiple alarms, cameras with alarms will display sequentially. When set to Off, that Spot Monitor's display does not change during Manual alarm conditions.
- **Hold Time** : This allows the user to set the alarm actions to last from 1 to 99 seconds. Hold Time is applicable only if the alarm action is set to Timed OUT.
- **Next >** : This takes you to the Manual Alarm Action Setup (2) submenu.
- **Exit** : Saves your changes and returns to the previous menu.

## Manual Alarm Action Setup (2)

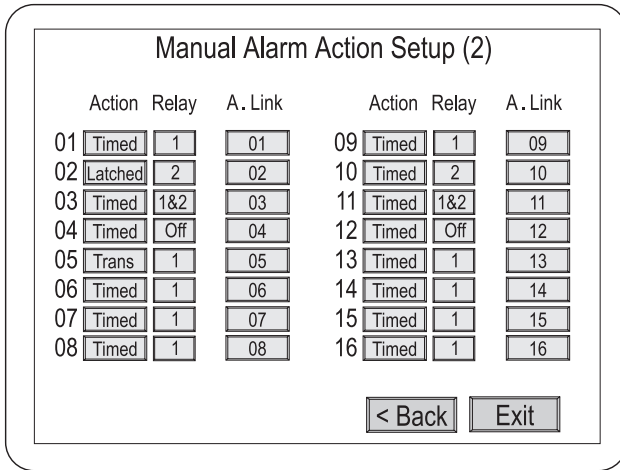

< Figure 22 > Manual Alarm Action Setup (2) screen.

This screen allows you to set the actions the operator can take, what relays will be activated and what cameras are associated with other cameras.

- Action** : There are three possible settings. Timed: The alarm will “time out” at the designated time (Hold Time) unless the operator clears it earlier.  
 Latched : The alarm remains active until the operator acknowledges it. Trans (Transparent): The alarms are not latched and cannot be cleared by the operator.
- Relay** : There are four possible relay settings. 1 or 2: Sets either internal relay 1 or 2 to be activated by an alarm. 1&2: Sets both internal relays 1 and 2 to be activated by an alarm. Off: Neither internal relay will be activated by an alarm.
- Alarm Link** : This selects whether the alarm action will be linked or not. It can be set to Off or any of the 16 alarm actions. All alarm actions take priority over manual alarm actions.

- **<Back** : This takes you to the Manual Alarm Action Setup (1) submenu.
- **Exit** : Saves your changes and returns to the previous menu.

## Macro Link Setup

---

Alarm No.	Macro No.	Alarm No.	Macro No.
01	01	09	09
02	02	10	10
03	03	11	11
04	04	12	12
05	05	13	13
06	06	14	14
07	07	15	15
08	08	16	16

Exit

< Figure 23 > Macro Link Setup screen.

This screen allows you to link macros to the 16 alarms. Each alarm can be set to Off or linked to any of 16 macros.

- **Exit** : Saves your changes and returns to the previous menu.

## Alarm History

Alarm History List					
Index	Alarm Source	Cam	Time	Date	User
001	Motion	01	02:00:23	11/24/2000	1
002	Ext. Pin	02	01:00:20	11/24/2000	1
003	Manual	03	23:00:10	11/23/2000	1
004	V.loss	04	22:20:30	11/23/2000	1
005	Motion	05	21:10:40	11/23/2000	S
006	Ext. Pin	06	20:00:53	11/23/2000	S
007	Manual	07	17:00:30	11/23/2000	S
008	V.loss	08	15:00:00	11/23/2000	S
009	Motion	09	12:40:15	11/23/2000	2
010	Ext. Pin	10	12:10:30	11/23/2000	2
011	Manual	11	11:50:20	11/23/2000	2
012	V.loss	12	11:20:10	11/23/2000	2
013	Motion	13	10:15:40	11/23/2000	3
014	Ext. Pin	14	10:07:43	11/23/2000	3
015	Manual	15	09:20:45	11/23/2000	4
016	V.loss	16	09:05:20	11/23/2000	4

< Figure 24 > Alarm History List screen.

This screen displays a list of alarms. The multiplexer retains a history of up to 256 events.

- << : Goes to the first page in the history list.
- < : Goes back one page in the history list.
- > : Goes forward one page in the history list.
- >> : Goes to the last page in the history list. (maximum 16 pages)
- **Clear** : This clears all the information from the history list. You will be asked to confirm that you really want to delete all the alarm history information before it is deleted.
- **Print** : Transmits all alarm history list to PC.

**NOTE** : Before implement "Print" function, make sure follow the below steps.

1. Go to the vender's website.

2. Download the "Download.exe" file on your PC.
  3. Implement the "Download.exe" file and click the icon named "Print Program".
  4. Now user's are ready to use "Print" function.
- **Exit** : Saves your changes and returns to the Main Menu.

## Motion Detection Setup

---

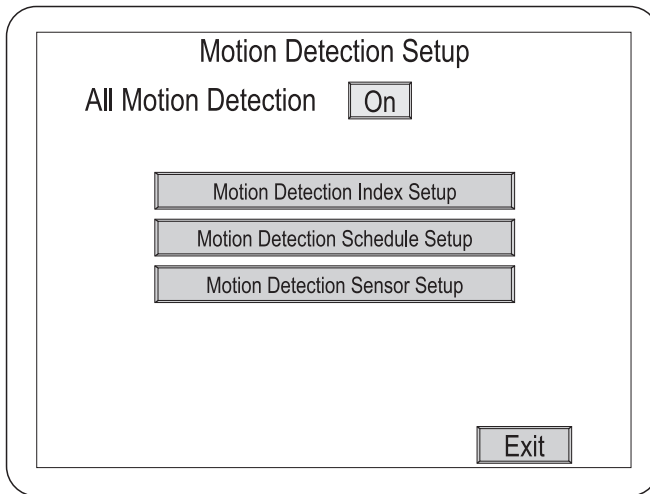

< Figure 25 > Motion Detection Setup screen.

The Motion Detection Setup screen is the starting point for various motion detection setup screens.

- **All Motion Detection:** This is a global switch that turns motion detection for all cameras On or Off.
- **Motion Detection Index Setup:** Takes you to that submenu.
- **Motion Detection Schedule Setup:** Takes you to that submenu.
- **Motion Detection Sensor Setup:** Takes you to that submenu.
- **Exit:** Saves your changes and returns to the Main Menu.

## Motion Detection Index Setup

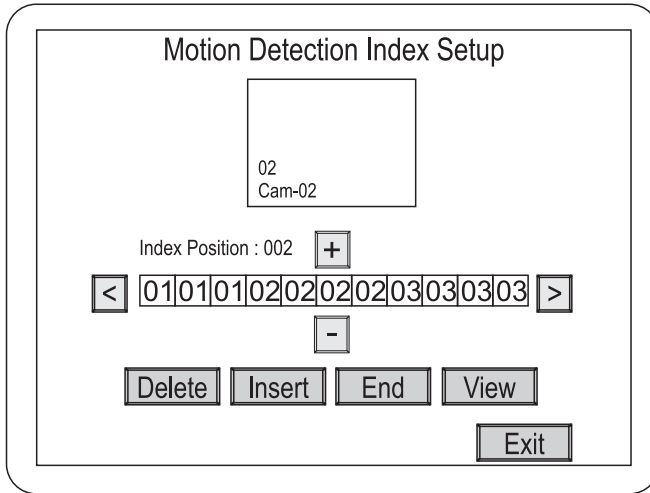

< Figure 26 > Motion Detection Index Setup screen.

Normally, the multiplexer gives equal priority to all cameras (1 to 16) for motion detection. However, it is possible to change the priorities.

- **+** : Increases the camera number by one.
- **-** : Decreases the camera number by one.
- **<** : Scrolls through the camera array to the left.
- **>** : Scrolls through the camera array to the right.
- **Delete** : Deletes the highlighted camera from the array.
- **Insert** : Inserts a blank into the array.
- **End** : Enters an “E” which sets the end mark for the index list.
- **View** : Displays the Motion Detection Index List.
- **Exit** : Saves your changes and returns to the previous menu.

## Motion Detection Index List

---

Motion Detection Index List															
01	01	01	01	02	02	02	02	02	02	02	02	02	02	02	02
03	03	03	03	04	??	04	04	04	04	04	04	04	04	04	04
05	05	05	05	06	06	06	06	06	06	06	06	06	06	06	06
07	07	07	07	08	08	08	08	08	08	08	08	08	08	08	08
09	09	09	09	10	10	10	10	10	10	10	10	10	10	10	10
11	11	11	11	12	12	12	12	12	12	12	12	12	12	12	12
13	13	13	13	14	14	14	14	14	14	14	14	14	14	14	14
15	15	15	15	16	16	16	16	E	16	16	16	16	16	16	16

< Figure 27 > Motion Detection Index List screen.

This screen displays the priorities assigned to the cameras. You cannot edit anything on this screen.

- **Exit** : Returns to the previous menu.



## Motion Detection Schedule Setup

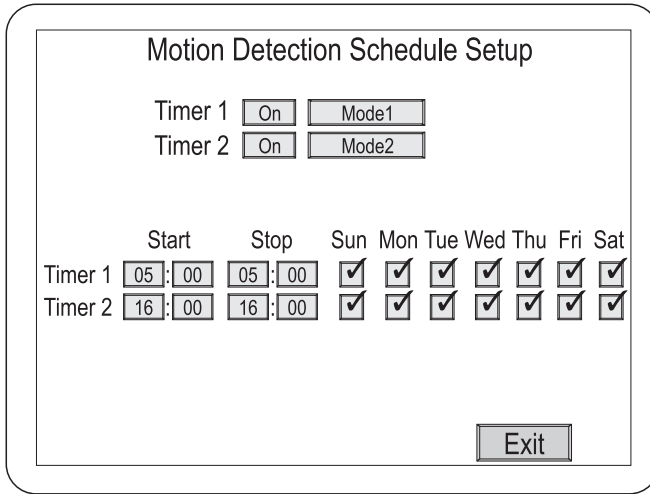

< Figure 28 > Motion Detection Schedule Setup schedule.

The multiplexer can be set up to detect or ignore motion based on a schedule. For example, you would expect lots of activity during normal office hours and do not want to detect motion. However, when the office is closed, motion should generate an alarm condition.

- **Timer 1 & 2** : Each timer can be turned On or Off, and they can be set to Mode 1 or 2. (Modes 1 and 2 are defined in the Motion Detection Sensor Setup screen.)
- **Start & Stop** : You can set the start and stop time for each timer. A start time of 18:00 with an end time of 06:00 will go from 6:00 p.m. until 6:00 a.m. of the following morning.
- **Days** : The timers can be turned On or Off for each day of the week.  
✓ = On and O = Off.
- **Exit** : Saves your changes and returns to the previous menu.

## Motion Detection Sensor Setup

---

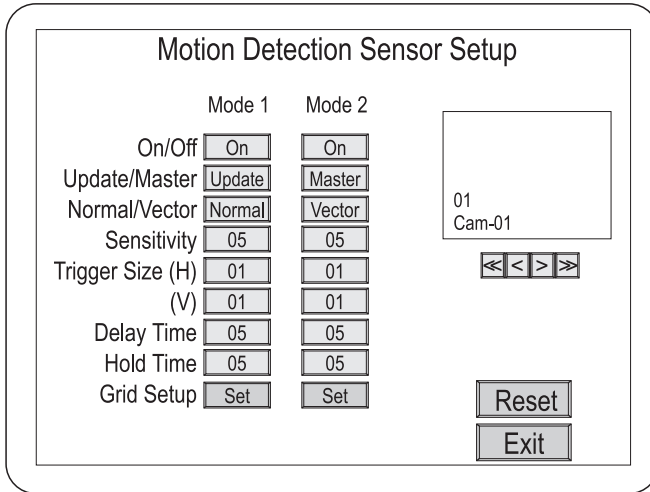

< Figure 29 > Motion Detection Sensor Setup screen.

Each camera can be set up with two sets of motion detection parameters. The parameter sets are defined as Mode 1 and Mode 2. (You can schedule when the modes will be used in the Motion Detection Schedule Setup screen.)

- **On/Off** : Turns motion detection On or Off.
- **Update/Master** : When using Update, the multiplexer compares the current field with the previous one. When using Master, the multiplexer compares a master image to continuous video.
- **Normal/Vector** : When set to Normal, the multiplexer detects all motion. When set to Vector, the multiplexer detects motion based on user definitions.
- **Sensitivity** : Sets how much luminance change there must be in the target area before the multiplexer reads the change as motion. 01 is the lowest sensitivity and 16 is the highest.

- **Trigger Size (H)** : This is the minimum number of targets in a horizontal row that must change before the multiplexer reads the change as motion. The range is 01 to 16.
- **Trigger Size (V)** : This is the minimum number of targets in a vertical row that must change before the multiplexer reads the change as motion. The range is 01 to 16.
- **Delay Time** : The delay time is used to make adjustments for scenes that have sudden changes such as lights and shadows created by headlights of nearby traffic. The delay can be set from 0 to 5 seconds.
- **Hold Time** : The Hold Time can be set from 1 to 99 seconds.
- **Grid Setup** : Takes you to the Motion Detection Sensor Setup screen.
- **<<** : Goes to Camera 1.
- **<** : Goes back one camera.
- **>** : Goes forward one camera.
- **>>** : Goes to Camera 16.
- **Reset** : Returns all settings to the motion detection sensor setup default.
- **Exit** : Saves your changes and returns to the previous menu.

## Motion Detection Sensor Setup (Normal)

---

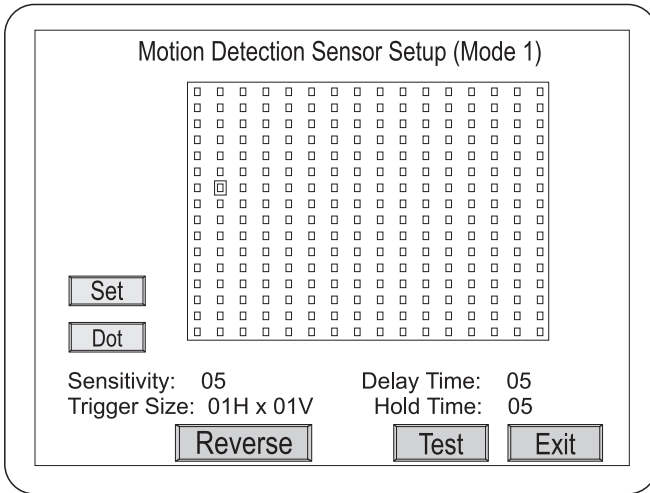

< Figure 30 > Motion Detection Sensor Setup (Normal) screen.

The Motion Detection Sensor Setup screen is used to setup and test cameras for motion detection. Mode 1 and Mode 2 can be set up for either Normal or Vector motion detection. The following describes Normal motion detection.

- **SET** : Highlights the grids area.  
Click of the mouse on this icon has no action.
- **Dot/Line/All** : Determines how many targets will be turned on or off.  
Dot = single target. Line = a row of targets. All = all the targets.
- **Reverse** : Set all targets to the reverse side.
- **Test** : Goes to the Motion Detection Sensor Setup test screen.
- **Exit** : Saves your changes and returns to the previous menu.

## Testing Motion Detection Sensor Setup

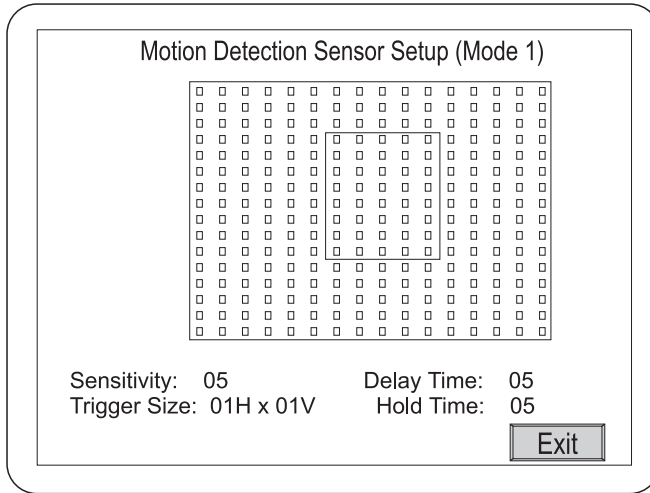

< Figure 31 > Motion Detection Sensor Setup test screen.

The Motion Detection Sensor Setup test screen shows when the multiplexer detects motion by drawing a box around the active area. This gives you instant feedback letting you know if you have set the correct size and sensitivity for the types of motion you want to detect.

- **Master Screen Set** : Saves the master image. (This button only appears in the Master Mode.)
- **Exit** : Returns to the previous menu.

## Motion Detection Sensor Setup (Vector)

---

The Vector Motion Detection Sensor Setup screen is the same as the Normal Motion Detection Sensor Setup screen except that it has two motion grids. To detect left to right motion, you define the first grid and then define a second grid to the right of the first.

- **A ON** : Used to define the first grid.
- **B ON** : Used to define the second grid.

Refer to Motion Detection Sensor Setup (Normal) for descriptions of all the other settings.

## Playback & Recording Setup

---

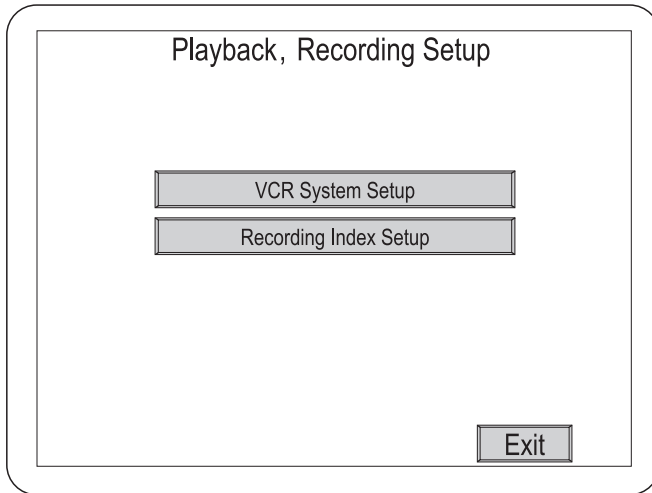

< Figure 32 > Playback & Recording Setup screen.

The Playback & Recording Setup screen gives you access to submenus for setting up playback and recording.

- **VCR System Setup** : Opens the submenu.
- **Recording Index Setup** : Opens the submenu.
- **Exit** : Saves your changes and returns to the Main Menu.

## VCR System Setup

VCR System Setup

VCR Input	BNC									
External Trigger	+									
Panic Rec Buzzer	Off									
VCR Type	User Define									
<table style="width: 100%; border-collapse: collapse;"> <thead> <tr> <th style="width: 50%;"></th> <th style="width: 25%; text-align: center;">Hour</th> <th style="width: 25%; text-align: center;">Field</th> </tr> </thead> <tbody> <tr> <td>Normal Record</td> <td style="text-align: center;">003</td> <td style="text-align: center;">001</td> </tr> <tr> <td>Alarm Record</td> <td style="text-align: center;">003</td> <td style="text-align: center;">001</td> </tr> </tbody> </table>			Hour	Field	Normal Record	003	001	Alarm Record	003	001
	Hour	Field								
Normal Record	003	001								
Alarm Record	003	001								
Exit										

< Figure 33 > VCR System Setup screen.

The VCR System Setup screen is used to synchronize the multiplexer with your VCR.

**NOTE :** *If your VCR has a synchronizing trigger pulse, using it will save you a lot of time when setting up your system.*

- **VCR Input :** There are two options for multiplexer input from the VCR: BNC and S-Video.
- **External Trigger :** Set to Off if you are not using the VCR's synchronizing trigger pulse. When using your VCR's synchronizing trigger pulse, set to match the VCR's signal; + for positive edge sensing and – for negative edge sensing.
- **Panic Rec Buzzer :** When On, the buzzer will beep every 20 seconds.
- **VCR Type :** Selecting this brings up a list of VCRs. Select your VCR from the list. If your VCR is not on the list select User Define.

- **Normal & Alarm Record** : If you selected a VCR from the list, all you need to set is the hours. If you selected User Define, you need to set the hours and field delay. Although you can set Normal and Alarm hours the same, you usually want higher quality video in an alarm situation. For example, you might set Normal to 24-hour time-lapse and Alarm to 2-hour mode. You will need to get the field delay rates from your VCR manufacturer.
- **Exit** : Saves your changes and returns to the previous menu.

## Recording Index Setup

---

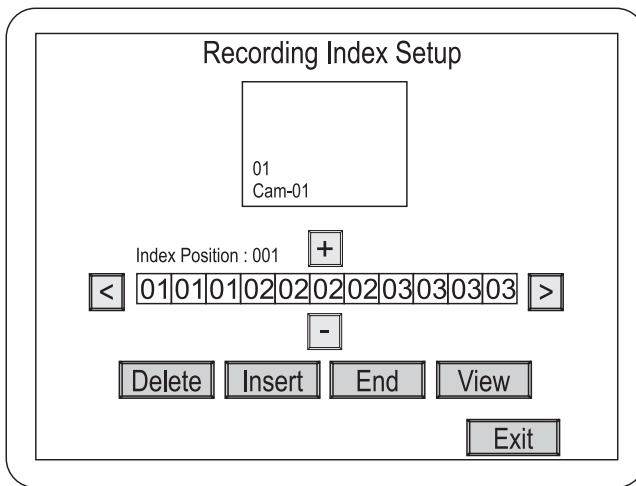

< Figure 34 > Recording Index Setup screen.

Normally, the multiplexer gives the same priority to all cameras. However, you can set it up so that cameras are given different recording priorities.

- **+** : Increases the camera number by one.
- **-** : Decreases the camera number by one.
- **<** : Scrolls through the camera array to the left.
- **>** : Scrolls through the camera array to the right.



- **Delete** : Deletes the highlighted camera from the array.
- **Insert** : Inserts a blank into the array.
- **End** : Enters an “E” which sets the end mark for the index list.
- **View** : Displays the Motion Detection Index List.
- **Exit** : Saves your changes and returns to the previous menu.

## Camera Picture Adjustment

---

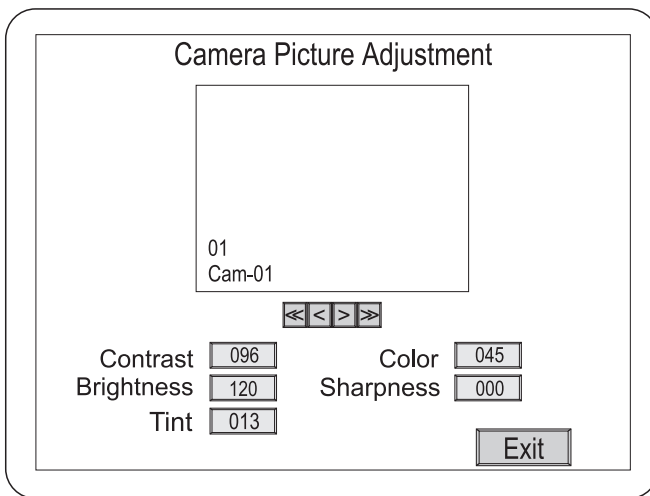

< Figure 35 > Camera Picture Adjustment screen.

**NOTE** : Do not make any adjustments with this screen until all of the cameras and monitors have been adjusted properly.

- << : Goes to Camera 1.
- < : Goes back one camera.
- > : Goes forward one camera.
- >> : Goes to Camera 16.

The following adjustments have a default setting of 00. The other values are Min = minimum, 127 to -01 = adjustments below default, 01 to 127 = adjustments above default, and Max = maximum.

- **Contrast** : Adjusts contrast.
- **Color** : Adjusts color.
- **Brightness** : Adjusts brightness.
- **Tint** : Adjusts tint. (Not available when the multiplexer is set for PAL operation.)
- **Sharpness** : Adjusts sharpness.
- **Exit** : Saves your changes and returns to the Main Menu.

# Macro Setup

---

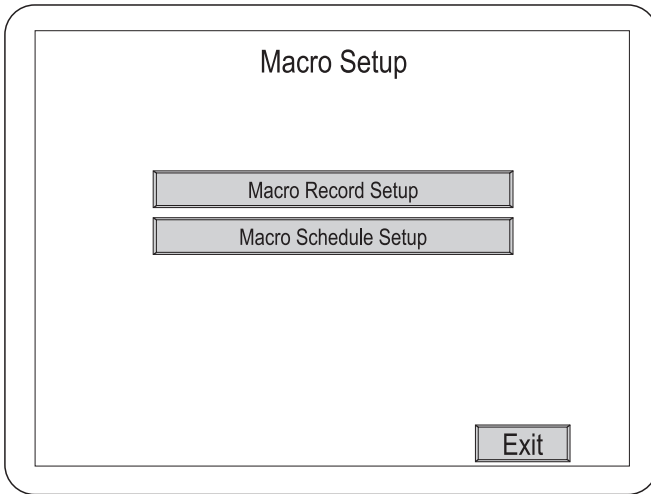

< Figure 36 > Macro Setup screen.

The Macro Setup screen lets you access the two macro setup submenus.

- **Macro Recording Setup** : Opens the submenu.
- **Macro Schedule Setup** : Opens the submenu.
- **Exit** : Saves your changes and returns to the Main Menu.

## Macro Record Setup

---

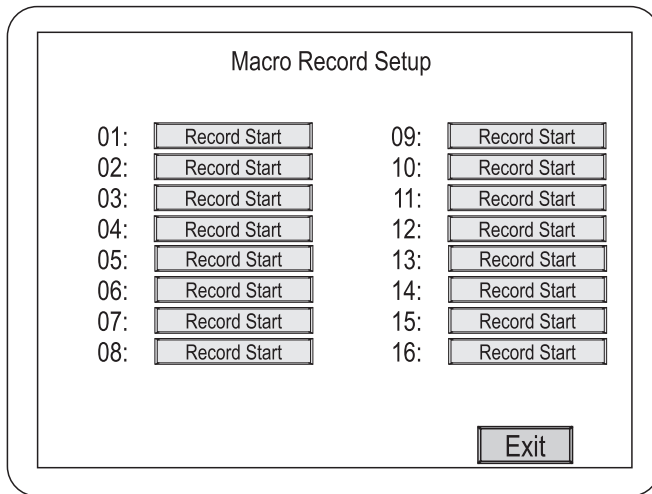

< Figure 37 > Macro Record Setup screen.

Selecting any of the Record Start buttons takes you to a live screen where all of your key strokes or mouse operations except for password protected operations will be recorded as a macro.

- **Exit** : Saves your changes and returns to the previous menu.

Right Button of mouse at the top of screen			
M01 REC	12:00:00	03/02/2001	
01 Cam-01	02 Cam-02	03 Cam-03	04 Cam-04
05 Cam-05	06 Cam-06	07 Cam-07	08 Cam-08
09 Cam-09	10 Cam-10	11 Cam-11	12 Cam-12
13 Cam-13	14 Cam-14	15 Cam-15	16 Cam-16

< Figure 38 > Live screen with M01 REC on the screen.

## Macro Schedule Setup

Macro Schedule Setup

Event

On/Off

Macro  Hour  : Min

Sun  Mon  Tue  Wed  Thu  Fri  Sat

< Figure 39 > Macro Schedule Setup screen.

You can create up to 20 event schedules that use macros.

- **Event** : Scheduled event number; 01 through 20
- **On/Off** : Turns the selected event On or Off.
- **Macro** : Selects the macro that that event is to perform.
- **Time** : Sets the time the event is to be done.
- **Day** : Sets the day(s) the event is to be done. ✓ = enables the event.  
O = disables the event.
- **Exit** : Saves your changes and returns to the previous menu.

## Unit Setup

---

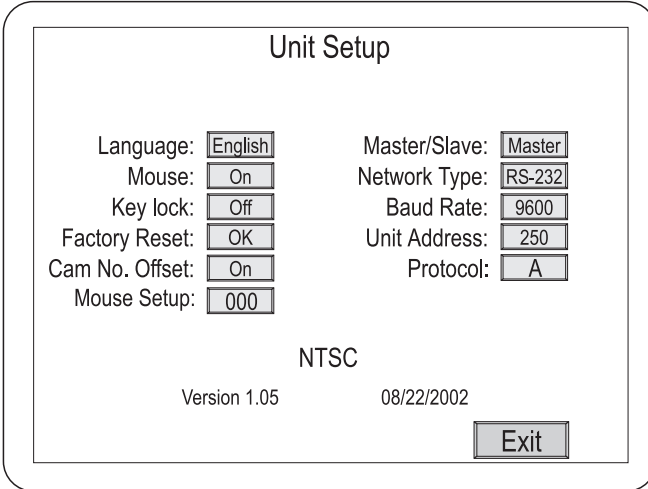

The screenshot shows a 'Unit Setup' menu with the following settings:

Language:	English	Master/Slave:	Master
Mouse:	On	Network Type:	RS-232
Key lock:	Off	Baud Rate:	9600
Factory Reset:	OK	Unit Address:	250
Cam No. Offset:	On	Protocol:	A
Mouse Setup:	000		

NTSC

Version 1.05      08/22/2002

Exit

< Figure 40 > Unit Setup screen.

This screen allows you to change the multiplexer basic settings.

- **Language** : There are five languages available: English, French, Italian, German, Polish and Spanish.

- **Mouse** : If you plan to use a mouse to control you multiplexer, set this to On.
- **Key lock** : When On, pressing any key or clicking the mouse will open a screen asking for a password.
- **Factory Reset** : Returns all settings to the factory default. A confirmation screen will ask you if you really want to reset everything.
- **Cam No. Offset** : When set to On, the multiplexer will adjust the camera numbers based on the Unit Address. Unit 001 will have Cameras 01 to 16, Unit 002 will have Cameras 17 to 32, etc. When set to Off, the cameras will be numbered 01 to 16.
- **Mouse setup** : If the mouse cannot be worked properly, the user can change the values as follows.  
The ranges which can be changed are Min=minimum, -009~009 and Max=maximum.
- **Master/Slave** : When installed as part of a network, this will determine if the unit is a master or slave unit.
- **Network Type** : The multiplexer can be set to RS-232, RS-422 or RS-485 when connected to a network.
- **Baud Rate** : When connected to a network, the baud rate can be set to 1200, 2400, 4800, 9600 or 19200.
- **Unit Address** : Networked multiplexers can be assigned addresses from 001 to 255.
- **Protocol** : A is multiplexer protocol.  
B1 is dome camera control protocol.
- **Exit** : Saves your changes and returns to the Main Menu.

# Password Setup

---

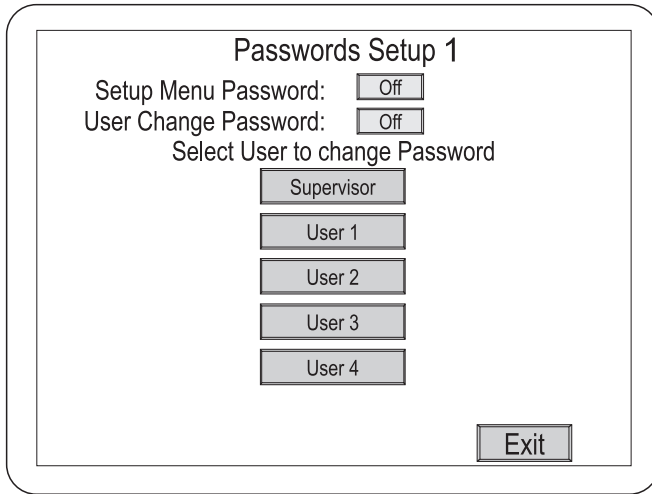

< Figure 41 > Passwords Setup screen.

**NOTE :** *Keep a copy of the supervisor password in a safe place. Once you have changed the supervisor password from the factory default, you will not be able to access protected menus without it.*

The Password Setup screen allows you to assign PIN codes to the supervisor and up to four users.

- **Setup Menu Password :** When On, only the supervisor can enter and make changes in the Setup Menu.
- **User Change Password :** When On, a password will be required to make screen configuration changes or to access items on the Pop Up menu.
- **Supervisor :** Opens the Password Entry screen.
- **User 1 to 4 :** Opens the Password Entry screen.
- **Exit :** Saves your changes and returns to the Main Menu.



## Assigning Passwords

---

Passwords Setup 2

User 1 Password: ●●○○

Retry Password: ○○○○

Clear

1 2 3 4 5 6 7 8 9 0

OK Cancel

Enter Password

< Figure 42 > Passwords entry screen.

Use the numbers to enter a four-digit PIN.

- **Clear** : Deletes all entered numbers, and you can restart entry.
- **OK** : Opens the re-enter screen after the first try. Compares the entry to the first password, and exits the Setup Menu if they match.
- **Cancel** : Cancels the password setup and exits the Setup Menu.



## Chapter 3 Operation

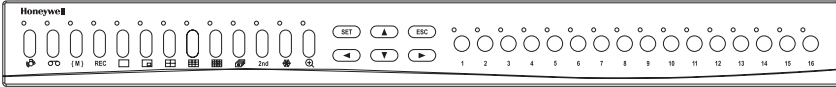



< Figure 43 > Front Panel.

### Buttons and Their Functions

 Allows the operator to generate an alarm. When pressed along with a camera button, it places that camera in the alarm mode.

- **OPERATION** : Press  and then a camera button.

 Pressing this button switches the multiplexer into VCR playback mode or VCR preview mode.

- **OPERATION** : Press  to switch the multiplexer into VCR playback mode. Press 2nd and then  to switch the VCR to preview mode.



**{M}** Plays a Macro.

- **OPERATION** : Press **{M}** and then a camera button to play macros 1 to 16.

**REC** Puts a camera in the Panic Record Mode.

- **OPERATION** : Press **REC** and then a camera button to put that camera in the panic record mode.



 Puts the multiplexer in Full-Screen Mode or the first user-defined display mode.

- **OPERATION** : Press  and the currently selected camera displays full screen. Pressing another camera button will display that camera full screen. Press **2nd** and then  to display a screen layout previously defined by the user.



 PIP (Picture in Picture) inserts a selected camera as a small image in the main image.

- **OPERATION** : Press  and then the camera button of the camera you want displayed in the insert.



 Puts the multiplexer in 2x2 display mode or the second user-defined display mode

- **OPERATION** : Press  and four cameras display on the screen. Press **2nd** and then  to display the second screen layout previously defined by the user.



 Puts the multiplexer in 3x3 display mode or the third user-defined display mode

- **OPERATION** : Press  and nine cameras display on the screen. Press **2nd** and then  to display the third screen layout previously defined by the user.

 Puts the multiplexer in 4x4 display mode or the fourth user-defined display mode

- **OPERATION** : Press  and 16 cameras display on the screen. Press **2nd** and then  to display the fourth screen layout previously defined by the user.

 Puts the multiplexer in the Sequence Mode.

- **OPERATION** : Press  to start or stop all cameras sequencing while in the 2x2, 3x3, PIP or User-defined Modes 1 to 4. Press  while in the Full-Screen Mode to start or stop a User-defined sequence.



Press **2nd**,  and camera buttons 1, 2, 3 or 4 to start or stop Spot Sequences 1 to 4 respectively.

Press **ESC** and  to start Stack Sequence which sequences through multi-format screens.

**2nd** In addition to its other functions, the **2nd** button can be used to assign cameras to the Spot monitors.

- **OPERATION** : Press **2nd** then 1, 2, 3 or 4 to select the Spot monitor; then press camera button of the camera you want displayed on that Spot monitor. You can assign any one of the 16 cameras to any of the four Spot monitors.

 This button freezes the video.

- **OPERATION** : Press  to freeze the video from the currently selected camera. Press **ESC** then  to freeze the video from all the cameras.

 This button enters the Zoom Mode.

- **OPERATION** : Press  to enter the Zoom Mode.

**SET** This button has several functions; it brings up a Popup Menu, sets selections on the OSD menus and decreases numbers in the number setup function.

- **OPERATION** : Press **SET** to enter the Popup Menu or to set a selected item from on of the menus.

**ESC** This button has several functions; it acts as a “Cancel” button, clears Cameo selections and increases numbers in the number setup function.

- **OPERATION** : Press **ESC** to cancel entries, clear the Cameo or to decrease the number.



The Up, Down, Left and Right buttons are used whenever you need to move the cursor, highlight bar or Cameo window.

- **OPERATION** : Press the arrow corresponding to the direction you want to move.

**1 to 16** These buttons are used to make camera selections or enter numbers as needed.

## Menu Operation

---

The multiplexer takes advantage of On-Screen Display (OSD) menus. You can navigate through these menus using a mouse or the arrow buttons. There are two main menus: Top and Bottom. The Top Menu is accessed by moving the cursor to the top edge of the screen. The Bottom Menu is accessed by moving the cursor to the bottom edge of the screen.

### Top Menu

---



< Figure 44 > Top Menu

The Top Menu has five selections.

- **Live** : Clicking on Live returns to the last Live mode screen format displayed.
- **Playback** : Clicking on Playback returns to the last screen format accessed in the Playback mode.
- **Preview** : Clicking on Preview displays the Preview mode.
- **Setup** : Clicking on Setup opens the Setup Menu. This feature is password protected. (See Chapter 2 for a description of the Setup Menu.)
- **Cancel** : Clicking Cancel exit the top menu without any changes.

### Bottom Menu

---

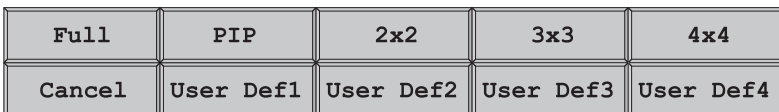

< Figure 45 > Bottom Menu

The bottom menu is only available in the Live Mode. It has ten selections.

- Full : Switches to full screen display of one camera.
- PIP : Switches to a display with a Picture-in-Picture
- 2x2 : Switches to four cameras displayed on the screen.
- 3x3 : Switches to nine cameras displayed on the screen.
- 4x4 : Switches to all 16 cameras displayed on the screen.
- User Def1 to 4 : Switch to user defined displays 1 to 4.
- Cancel : Exits the menu without any changes.

## Live Screen

---

12:00:00		03/02/2001	
01 Cam-01	02 Cam-02	03 Cam-03	04 Cam-04
05 Cam-05	06 Cam-06	07 Cam-07	08 Cam-08
09 Cam-09	10 Cam-10	11 Cam-11	12 Cam-12
13 Cam-13	14 Cam-14	15 Cam-15	16 Cam-16

< Figure 46 > 4x4 Live Screen.

When you move the mouse around while in the live screen mode or when you press the Up, Down, Left and Right arrow buttons, the border around the selected camera image will change to white. This indicates that camera image is ready for an action.

## Pop Up Menu

---

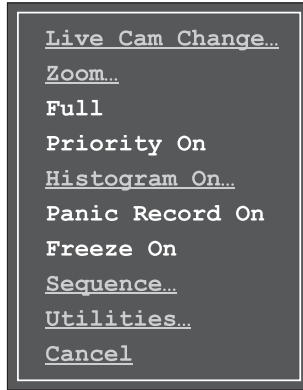

< Figure 47 > Pop Up Menu

Clicking the right mouse button or pressing the SET button cause the Pop up menu to appear. There is a list of ten items that can be selected from the Pop Up menu.

- **Live Cam Change...** : Allows you to select the “Live” camera.
- **Zoom...** : Enters the digital zoom mode.
- **Full** : Displays the selected camera full screen.
- **Priority** : Toggles between On and Off.
- **Histogram** : Toggles between On and Off.
- **Panic Record** : Toggles between On and Off.
- **Freeze** : Toggles between On and Off.
- **Sequence...** : Enters the Sequence setup mode.
- **Utilities...** : Enters the Utilities mode.
- **Cancel** : Closes the menu.



# Live Camera Change

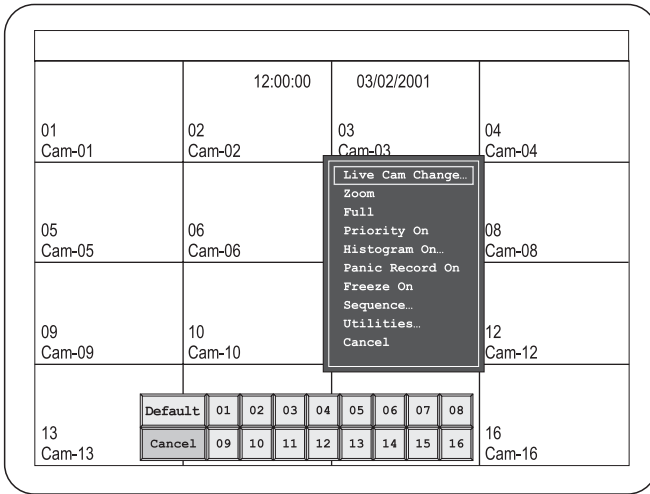

< Figure 48 > Live Cam Change menu

The Live Camera Change menu allows you to assign any camera to active cameo.

- **1 to 16** : Selecting these buttons changes the cameo camera.
- **Cancel** : Exits the menu without any changes.

## VCR Camera Change

---

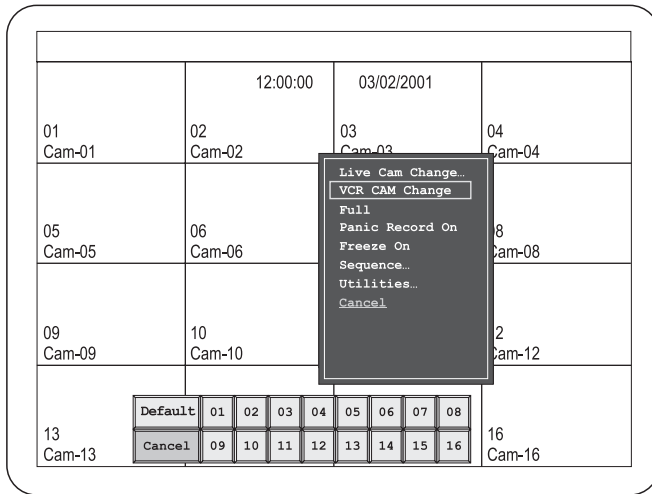

< Figure 49 > VCR Cam Change menu

This menu will appear on the Pop Up menu only when the unit is Playback mode.

The VCR Camera Change menu allows you to assign any camera to active cameo.

- **1 to 16** : Selecting these buttons changes the cameo camera.
- **Cancel** : Exits the menu without any changes.

## Zoom

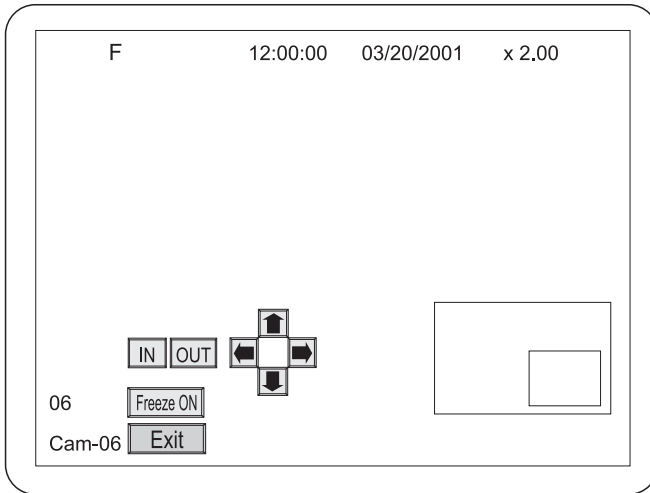

< Figure 50 > Zoom Screen.

The digits on the top right of the screen indicate the amount of zoom. The maximum zoom is 32 times.

The picture insert at the bottom right shows the entire scene with a rectangle representing the zoomed area.

- **Freeze** : Clicking this freezes the image on the screen.
- **In** : Zooms in (enlarges).
- **Out** : Zooms out.
- **Arrow buttons** : The arrow buttons are used to move the zoomed area left, right, up and down.
- **Exit** : Clicking this button exits the Zoom Mode.

## Full

---

Clicking Full on the Pop Up menu causes the active camera to display full screen.

## Priority On

---

When Priority is set to On for a camera, it will display in real time, and the refresh rate of the other cameras will slow down.

## Histogram Equalizer

---

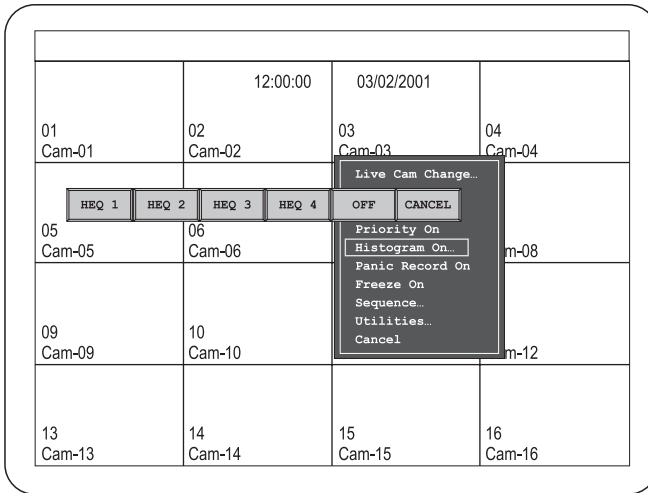

< Figure 51 > Histogram Equalizer menu bar.

- **HEQ1 to 4** : Each Histogram Equalizer button increases image contrast. HEQ1 has the weakest equalization and HEQ4 has the strongest equalization.

**NOTE** : Image noise increases as you use stronger equalization. This is a property of the equalization algorithm and is does not indicate a problem with your system.

- **OFF** : Cancels any Histogram Equalizer settings and returns the image contrast to the original value.
- **Cancel** : Cancel exits the menu without any changes.

## Panic Record On

---

When Panic Record is selected only the selected camera is recorded, and it records in real-time speed.

## Freeze On

---

When Freeze is selected, the image is frozen on the screen until you reset it.

## Sequence

---

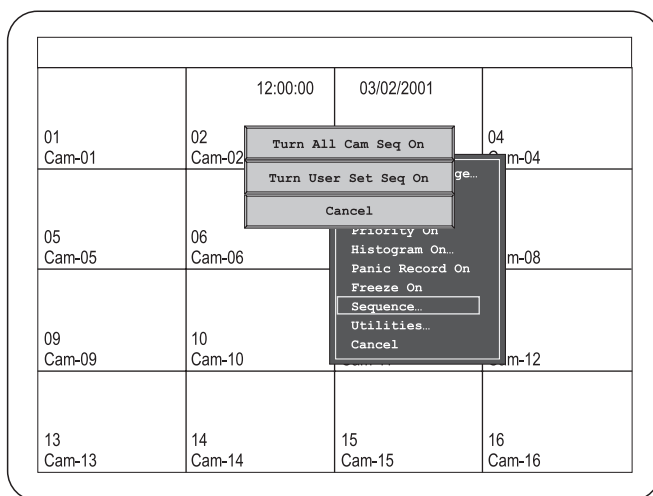

< Figure 52 > Sequence menu.

The Sequence selection displays the sequence menu.

- **Turn All Cam Seq On** : This selection starts sequencing all cameras that are not currently displayed on the screen.
- **Turn User Set Seq On** : This selection starts a sequence that was defined in the Setup Menu.
- **Cancel** : Exits the menu without any changes.

## Utilities

---

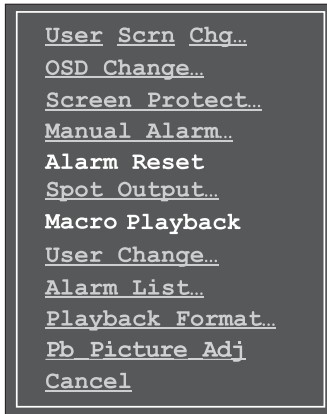

< Figure 53 > Utilities Pop Up menu.

## User Scrn Chg...

---



< Figure 54 > User Screen Change menu bar.

This opens the User Screen Change menu.

This menu allows the user to select one of four displays that were defined in the Bottom Menu. After selecting one of the UserDef buttons, the Select a Screen menu appears.

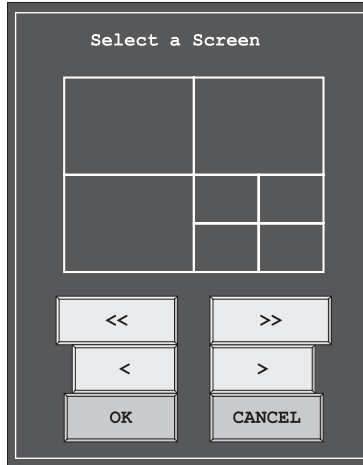

< Figure 55 > Select a Screen menu.

- << : Jumps back through the first screen formats at a time.
- < : Scrolls back through the screen formats one at a time.
- > : Scrolls forward through the screen formats one at a time.
- >> : Jumps forward through the last screen formats at a time.
- **OK** : Confirms the screen format selection.
- **Cancel** : Exits the menu without any changes.

## OSD Change...

---

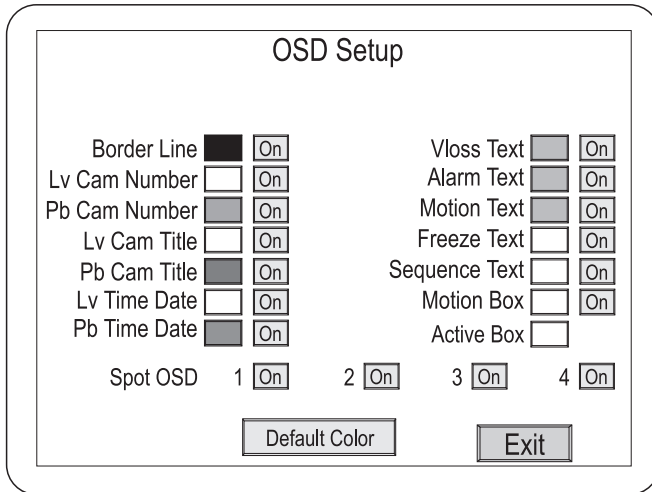

< Figure 56 > OSD Setup screen.

The OSD Setup screen allows you to select what text will be display and what color the text will be.

- **Border Line** : The border around the images.
- **Lv Cam Number** : The live camera's number.
- **Pb Cam Number** : The playback camera's number.
- **Lv Cam Title** : The live camera's title.
- **Pb Cam Title** : The playback camera's title.
- **Lv Time Date** : The live camera's time and date.
- **Pb Time Date** : The playback camera's time and date.
- **Vloss Text** : When the video signal is lost, a "V" displays on the screen.



- **Alarm Text** : When an alarm occurs, an “A” displays on the screen.
- **Motion Text** : When motion is detected, an “M” displays on the screen.
- **Freeze Text** : When an image is frozen, an “F” displays on the screen.
- **Sequence Text** : When the multiplexer is in sequence mode, an “S” displays on the screen.
- **Motion Box** : When motion is detected, a box showing the area displays on the screen.
- **Active Box** : When the camera is selected, the active window box displays.
- **Spot OSD** : The Spot OSD time, date and camera number, title.
- **Default Color** : Clicking this button resets the colors to factory default.
- **Available colors** : Black, Gray, White, Red, Green, Yellow, Magenta, Cyan and Blue.
- **Exit** : Saves your changes and returns to the live screen.

## Screen Protect...

---

The Screen Protect feature allows users to protect there setups against use or change by unauthorized persons.

## Manual Alarm

---

This feature allows the user to trigger an alarm manually.

## Alarm Reset

---

This feature allows the user to reset an alarm.

## Spot Output...

---



< Figure 57 > Spot output change screen.

This feature allows the user to assign different cameras to the spot monitors.

## Macro

---

This feature allows the user to select which macro will play.

## User Change...

---

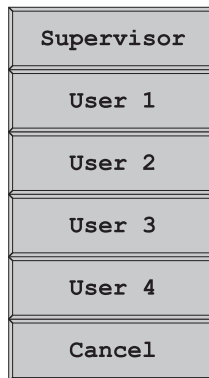

< Figure 58 >  
User Change menu.

Selecting Supervisor or one of the user numbers opens a password screen allowing that user to log on. The Supervisor has access to all the menus and setup features. Users can be assigned different levels of access. For example some users might not be able to view certain cameras.

## Alarm List...

Alarm History List					
Index	Alarm Source	Cam	Time	Date	User
001	Motion	01	02:00:23	11/24/2000	1
002	Ext. Pin	02	01:00:20	11/24/2000	1
003	Manual	03	23:00:10	11/23/2000	1
004	V.loss	04	22:20:30	11/23/2000	1
005	Motion	05	21:10:40	11/23/2000	S
006	Ext. Pin	06	20:00:53	11/23/2000	S
007	Manual	07	17:00:30	11/23/2000	S
008	V.loss	08	15:00:00	11/23/2000	S
009	Motion	09	12:40:15	11/23/2000	2
010	Ext. Pin	10	12:10:30	11/23/2000	2
011	Manual	11	11:50:20	11/23/2000	2
012	V.loss	12	11:20:10	11/23/2000	2
013	Motion	13	10:15:40	11/23/2000	3
014	Ext. Pin	14	10:07:43	11/23/2000	3
015	Manual	15	09:20:45	11/23/2000	4
016	V.loss	16	09:05:20	11/23/2000	4

Navigation buttons: << < > >> Clear Print Exit

< Figure 59 > Alarm History List.

This screen displays a list of alarms. The multiplexer retains a history of up to 256 events.

- << : Goes to the first page in the history list.
- < : Goes back one page in the history list.
- > : Goes forward one page in the history list.
- >> : Goes to the last page in the history list. (maximum 16 pages)
- **Print** : Transmits all alarm history list to PC.
- **Exit** : Returns to the previous screen.

## Playback Format...

---

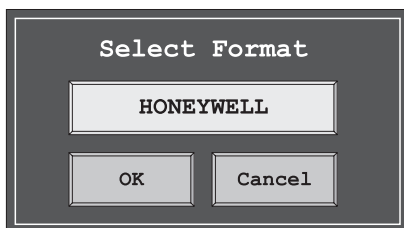

< Figure 60 > Select Format menu..

The multiplexer can play back tapes that were recorded using different multiplexers. This menu allows you to choose from HONEYWELL; DAVE; ULTRAK Legacy Color; ULTRAK Legacy B/W; DM; ROBOT; KALATEL.

## PB Picture Adjust...

---

This option appears on the Pop Up menu aonly when the unit is in the Playback Mode. It allows the user to adjust images played back from the VCR.

The following adjustments have a default setting of 00. The other values are Min = minimum, -127 to -01 = adjustments below default, 01 to 127 = adjustments above default, and Max = maximum.

- **Contrast** : Adjusts contrast.
- **Brightness** : Adjusts brightness.
- **Color** : Adjusts color.
- **Tint** : Adjusts tint. (Not available when the multiplexer is set for PAL operation.)
- **Sharpness** : Adjusts sharpness.
- **Cancel** : Closes the menu without any changes.

## Appendix A

# Troubleshooting

Problem	Try This
No Video (black screen)	Check power connections
No Video (one camera)	Check camera power and coaxial cable
No Video (jumbled colors)	Make certain multiplexer is set correctly for your system (NTSC or PAL)
Fuzzy Image (one camera)	Check camera focus
Bad Video (one camera)	Check the loop through connector. If a cable is attached, make certain it is connected to another video device on the other end.
Wrong Language	Change the language in the Setup Menu
Buttons Locked	Unlock buttons in Setup Menu.
Recorded Video Rolls	Check VCR configuration in Setup Menu. Use the trigger pulse from the multiplexer for optimum synchronization with a time-lapse VCR.
Tape Plays Only 4x4	Make certain video cable to the VCR input is connected to the VCR OUT of the multiplexer.
Too Many Motion Alarms	Adjust sensitivity of motion detection grid. Adjust size of grid required to activate motion alarm. Make certain only the area you want to detect motion is activated.
Motion Not Detected	Adjust sensitivity of motion detection grid. Adjust size of grid required to activate motion alarm. Make certain the area you want to detect motion is activated.

# Appendix B

## Connector Pin Outs

The multiplexer has a 50-pin connector used for alarm input and output, RS-232 network connections, VCR trigger pulse, and updating the multiplexer's firmware. A sub-board is supplied to simplify connections. See the illustration below for connection details.

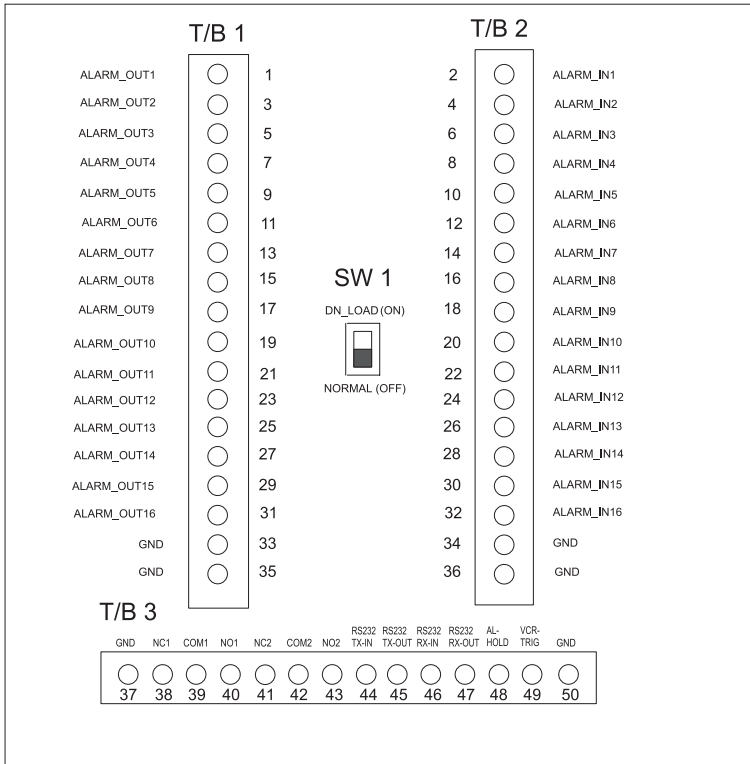

< Figure 61 > Connector Sub-Board

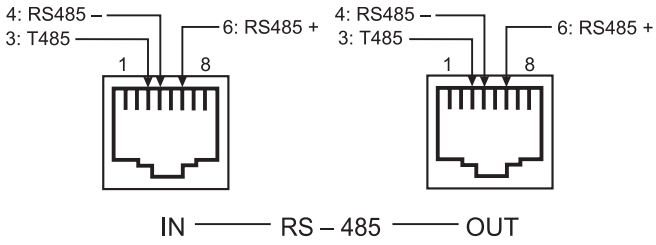

< Figure 62 > RS-485 Connector

**NOTE :** If termination of RS-485 network is required, short pin 3 and pin 4.

## Appendix C

# Remote Control

### Remote Control for Daisychained Multiplexers

---

If you are using a computer to control two or more daisy-chained multiplexers, you need to send a re-address command to select the multiplexer to control. (Up to 16 multiplexers can be daisy-chained.) Re-address commands are not printable characters; you need an 8-bit binary address or hex value to select which daisy-chained multiplexer you control. If you lose power to one or more multiplexers, you will need to use the re-address command again to select the correct multiplexer.

HEX	RESULTS	HEX	RESULTS
00	NUL (changes active multiplexer)	09	9 (9th connected multiplexer)
01	1 (1st connected multiplexer)	0A	10 (10th connected multiplexer)
02	2 (2nd connected multiplexer)	0B	11 (11th connected multiplexer)
03	3 (3rd connected multiplexer)	0C	12 (12th connected multiplexer)
04	4 (4th connected multiplexer)	0D	13 (13th connected multiplexer)
05	5 (5th connected multiplexer)	0E	14 (14th connected multiplexer)
06	6 (6th connected multiplexer)	0F	15 (15th connected multiplexer)
07	7 (7th connected multiplexer)	10	16 (16th connected multiplexer)
08	8 (8th connected multiplexer)		

< Table 1 > Re-Address Commands



## Remote Command Set

Simple three-character ASCII commands represent single or combination front panel button presses on the multiplexer. The effect of a button press or remote command depends on the multiplexer's current status. Check the multiplexer's current status before issuing a remote command. Because this multiplexer has a different front keys from the old model, some new commands are added to control the multiplexer correctly.

ASCII	MULTIPLEXER KEY	ASCII	MULTIPLEXER KEY
/PA	PALARM	/01	Camera 1
/TP	VCR	/02	Camera 2
/MA	MACRO	/03	Camera 3
/SX	RECORD	/04	Camera 4
/FZ	FULL	/05	Camera 5
/PP	PIP	/06	Camera 6
/22	2 x 2	/07	Camera 7
/33	3 x 3	/08	Camera 8
/44	4 x 4	/09	Camera 9
/SQ	SEQUENCE	/10	Camera 10
/2N	2ND	/11	Camera 11
/FR	FREEZE	/12	Camera 12
/ZO	ZOOM	/13	Camera 13
/ST	SET	/14	Camera 14
/ES	ESC	/15	Camera 15
/UP	UP	/16	Camera 16
/DO	DOWN		
/LE	LEFT		
/RI	RIGHT		

< Table 2 > Front key emulation commands

## Functional remote commands

HEX	RESULTS	HEX	RESULTS
/S1	Panic record (camera 1)	/X1	Select camera 1 for display
/S2	Panic record (camera 2)	/X2	Select camera 2 for display
/S3	Panic record (camera 3)	/X3	Select camera 3 for display
/S4	Panic record (camera 4)	/X4	Select camera 4 for display
/S5	Panic record (camera 5)	/X5	Select camera 5 for display
/S6	Panic record (camera 6)	/X6	Select camera 6 for display
/S7	Panic record (camera 7)	/X7	Select camera 7 for display
/S8	Panic record (camera 8)	/X8	Select camera 8 for display
/S9	Panic record (camera 9)	/X9	Select camera 9 for display
/SA	Panic record (camera 10)	/XA	Select camera 10 for display
/SB	Panic record (camera 11)	/XB	Select camera 11 for display
/SC	Panic record (camera 12)	/XC	Select camera 12 for display
/SD	Panic record (camera 13)	/XD	Select camera 13 for display
/SE	Panic record (camera 14)	/XE	Select camera 14 for display
/SF	Panic record (camera 15)	/XF	Select camera 15 for display
/SG	Panic record (camera 16)	/XG	Select camera 16 for display
/AV	Stop panic record	/_U	Up (press & hold arrow button)
/AF	Setup Menu	/_D	Down (press & hold arrow button)
/AU	Factory Reset	/_L	Left (press & hold arrow button)
/AD	Alarm History List	/_R	Right (press & hold arrow button)
/AL	Alarm History List	/AR	Time/Date OSD ON/OFF

< Table 3 > Remote commands

## Appendix D

# Specifications

### Operating Defaults

Display Format .....	4x4 multi-screen format
Operation Mode .....	Live

### Factory Defaults

Date Format .....	US (MM/DD/YY)
Time Format .....	24-hour
Clock Source .....	Internal clock
Daylight Saving .....	OFF
Camera Access .....	All cameras ON
Cameras to Record .....	All cameras ON
Stack Dwell Time .....	3 seconds
Sequence Dwell Time .....	3 Seconds
Alarm Reset Button .....	ON
Alarm Screen Format .....	4x4
Alarm Dwell Time .....	03 seconds
Alarm input Polarity .....	NO (Normally Open)
Alarm Output Polarity .....	AH (Active High)
Alarm Buzzer .....	ON
Alarm Screen .....	ON
Alarm Network Relay .....	OFF
Alarm Message Latch .....	ON
Alarm Recording .....	INT (Interleaving)
Alarm Spot Monitor Output .....	ON
Alarm Hold Time .....	20 Seconds
Alarm Action .....	Timed Out
Alarm Relay .....	1&2
Alarm Associated .....	3 sequential cameras followed by alarm camera
Motion Alarm Buzzer .....	OFF
Motion Alarm Screen .....	OFF
Motion Alarm Network Relay .....	OFF
Motion Alarm Message Latch .....	ON

Motion Alarm Recording .....	INT (Interleaving)
Motion Alarm Spot Monitor Output .....	OFF
Motion Alarm Action .....	Timed Out
Motion Alarm Relay .....	OFF
Motion Alarm Link .....	OFF
Vloss Buzzer .....	ON
Vloss Screen .....	OFF
Vloss Network Relay .....	OFF
Vloss Message Latch .....	ON
Vloss Spot Monitor Output .....	ON
Vloss Hold Time .....	20 Seconds
Manual Alarm Buzzer .....	ON
Manual Alarm Screen .....	ON
Manual Alarm Network Relay .....	OFF
Manual Alarm Message Latch .....	ON
Manual Alarm Recording .....	INT (Interleaving)
Manual Alarm Spot Monitor Output .....	ON
Manual Alarm Hold Time .....	20 Seconds
Manual Alarm Action .....	Timed Out
Manual Alarm Relay .....	1&2
Manual Alarm Associated .....	OFF
Alarm to Macro link .....	OFF
All Motion Detection .....	ON
Motion Detection Timer .....	OFF
Update/Master .....	Update
Normal/Vector .....	Normal
Sensitivity .....	10
Trigger Size (H x V) .....	1 x 1
Delay Time .....	0 Seconds
Motion Hold Time .....	5 Seconds
Target Grids .....	All Grids ON
VCR Input .....	BNC
External Trigger .....	OFF
Panic Record Buzzer .....	ON
VCR Type .....	Standard VHS
VCR Normal Record Time .....	2 Hours, 3 Hours (PAL)
VCR Alarm Record Time .....	2 Hours, 3 Hours (PAL)

Camera Contrast .....	00
Camera Brightness.....	00
Camera Color.....	00
Camera Tint.....	00
Language.....	English
Mouse.....	ON
Key Lock.....	OFF
Camera Number Offset.....	OFF
Master/Slave.....	Slave
Network Type.....	RS232
Baud Rate.....	1200
Unit Address.....	001
Protocol.....	A
Setup Menu Password.....	OFF
User Change Password.....	OFF
Password Code .....	User1 (1111)
	User2 (2222)
	User3 (3333)
	User4 (4444)
	Supervisor (5555)
VCR Picture Adjustment.....	00
Priority Display.....	OFF
Histogram Equalization.....	OFF
Border Line.....	ON (Black)
Live Camera Number.....	ON (white)
PB Camera Number.....	ON (Blue)
Live Camera Title.....	ON (White)
PB Camera Title.....	ON (Blue)
Live Time, Date.....	ON (White)
PB Time,Date.....	ON (Blue)
Vloss Text.....	ON (White)
Alarm Text.....	ON (White)
Motion Text.....	ON (White)
Freeze Text.....	ON (Red)
Sequence Text.....	ON (White)
Motion Box.....	OFF (Blue)

**Video format**

NTSC/PAL ..... Standard

**Video Level**

Camera Inputs ..... 1.0Vp-p, 75 Ohms  
 Camera Outputs ..... 1.0Vp-p, 75 Ohms  
 Loop through Output ..... 1.0Vp-p, 75 Ohms  
 VCR Input: Composite ..... 1.0Vp-p, 75 Ohms  
 VCR Input: S-Video ..... Luma 1.0Vp-p, 75 Ohms  
    Chroma (burst) 0.286Vp-p, 75 Ohms  
 Main Output: Composite ..... 1.0Vp-p, 75 Ohms  
 Main Output: S-Video ..... Luma 1.0Vp-p, 75 Ohms  
    Chroma (burst) 0.286Vp-p, 75 Ohms  
 Auxiliary Output ..... 1.0Vp-p, 75 Ohms

**Main Output Display Formats (live and playback)**

Full (digital)  
 Full (VCR input preview – digital)  
 Quad  
 9-way  
 16-way  
 “Squish” Horizontal (1/2, 1/3)  
 “Squish” Vertical (1/2, 1/3)  
 PIP with 1 inset (any position, 1/3, 1/4)  
 PIP with 2 insets (any position, 1/3, 1/4)  
 PIP with 3 insets (any position, 1/3, 1/4)  
 PIP with 4 insets (any position, 1/3, 1/4)  
 1+7 (3/4 x 1 + 1/16 x 7, 4 configurations)  
 1+5 (4/9 x 1 + 1/9 x 5, 4 configurations)  
 1+12 (1/4 x 1 + 1/16 x 12, 4 configurations)  
 2+8 (1/4 x 2 + 1/16 x 8, 4 configurations)  
 3+4 (1/4 x 3 + 1/16 x 4, 4 configurations)  
 Linear Zoom (1X to 32X) with electronic Pan & Tilt

**Resolution (pixels x lines)**

Sampling ..... NTSC : 720 x 480  
    PAL : 720 x 576  
 Full (Active) ..... 648 x 448 (648 x 518)  
    (10 to 9 down-scaling)

1/4 Size .....	324 x 224 (324 x 259)
1/9 Size .....	216 x 149 (216 x 173)
1/16 Size .....	162 x 112 (162 x 129)
4/9 Size .....	432 x 298 (432 x 346)
9/16 Size .....	486 x 336 (486 x 387)
VCR Out (full) .....	720 x 480 (720 x 576)
Spot Out .....	analog

### Sampling Standard

Y:Cb:Cr .....	CCIR 601 (4:2:2)
Gray Scale .....	256 levels
Color .....	16 million (True Color)

### Video Memory

Main Display .....	64Mbit SDRAM
VCR Output .....	64M/16Mbit SDRAM

### Refresh Rate (fields/sec.)

Full .....	60
PIP format (Main) .....	60
PIP format (inset) .....	60
Squish .....	60
Split format (1_2 cameras) .....	60
Split format (3-16 cameras) .....	60/number of cameras
Zoom .....	60
Spot Out .....	60
VCR Out (depends on field delay) .....	60 max
Priority Mode (major) .....	60
Priority Mode (minor) .....	30/Number of Cameras

### Display Options

Triplex (Live & Playback at same time)	
Full Sequence	
Cameo Sequence (any 1 position) .....	Split or PIP mode
Page Sequence (2x2, 3x3) .....	Squish, 4-way, 9-way
Freeze All	
Freeze One Camera	
Camera Assign	
Priority Assign (1 cam only)	

Motion Tracking Box  
Digital Contrast Enhancer

### **Motion Detection**

Activity Grid ..... (16 x 16 grids)  
Activity Detection  
Intrusion Detection  
Motion Vector Sensing (any direction)  
Sensitivity Levels ..... 01-16  
Motion Delay Time ..... 0 to 5 Seconds  
Motion Hold Time ..... 1 to 99 Seconds  
Day & Night Modes (2 setup modes)  
Interleaving (VCR Out)  
Motion Tracking Box (on screen Setup & Live)  
Two-way detecting algorithm ..... Update or Master screen mode

### **VCR Playback**

Multi-format Decoding (via setup).... Dedicated Micros, Robot®,  
Kalatel (Impac), Pelco™ and  
more

### **Alarm Operation**

Alarm Inputs ..... 16 inputs with individual polarity  
selection, activated by contact  
closure or TTL/CMOS signal  
Alarm Outputs ..... relay 2 NO and NC contacts with  
shared common, 1.0A and 24VDC  
(resistive only)  
Alarm Outputs ..... One output per camera,  
TTL/CMOS (Active High or Low  
selectable)  
Alarm Message Display  
Associated Alarm Setup ..... Up to 4 cameras  
Alarm Dwell Time ..... 1 to 99 Seconds  
Alarm Hold Time ..... 1 to 99 Seconds  
Alarm Buzzer ..... On/Off  
Manual Alarm Activation



Alarm History Logging .....	256 events
Alarm History Printout .....	via RS232
Link Alarms to Macro	
Link Alarms to VMD	
External Alarm Relay Box .....	16 relays via RS485

**On-Screen Display (Main)**

Camera Title .....	24 characters
Time & Date .....	U.S., Asia, European 12/24-hour format
Alarm Message	
Motion Message	
Video Loss Message	
Zoom Mode Message	
Freeze Mode Message	
Sequence Mode Message	
Setup Menu	
Camera Number	

**On-Screen Display (Spot)**

Camera Title .....	24 characters
Time & Date .....	U.S., Asia, European 12/24-hour format
Alarm Message	
Video Loss Message	
Motion Message	
Sequence Mode Message	
Camera Number	

**Other Features (Internal)**

Multi-User Password Protection .....	1 Supervisor, 4 Users
Keylock	
Daylight Saving Time .....	(key press & Menu)
Sequence Dwell Time .....	1 to 99 Seconds, OFF
Page (Stack) Sequence Dwell Time .....	1 to 99 Seconds

Time-lapse VCR Setup (field delay selectable)	2 hr real-time to 960 hr time-lapse
Video Loss Detection	
Factory Reset	
Unit ID Number	1 to 255
Picture Adjust (Live, Playback)	
Macro (1 per camera)	
Macro Scheduler	
Camera Number Offset	1 to 256
Multilingual Menu	English, German, French, Italian, Spanish, Polish
Camera Auto Detect	
Border Color Select	
Record Index List	
Panic Record	
Flash Memory Upgradable	via RS232

### Other Features (External Interface)

VCR Trigger Input	
Master/Slave TDG	via RS485
Master/Slave Setup	
PC Software Control	via RS232

### Remote Control

RS232	(1200 _ 19200 bps) RX/TX
RS485	(1200 _ 19200 bps) RX/TX
Mouse Control	

### Rear Panel Connectors

Camera Inputs	16 BNC
Loop Out (auto terminating)	16 BNC
Main Monitor Out (CVBS)	1 BNC
Main Monitor OUT (Y/C)	1 4-pin mini DIN
VCR In (CVBS)	1 BNC
VCR In (Y/C)	1 4-pin mini DIN
VCR Out (CVBS)	1 BNC

VCR Out (Y/C) .....	1 4-pin mini DIN
Alarm Input/Output .....	Terminal block
RS232 (RX/TX) .....	Terminal block
RS485 (RX/TX) .....	2 RJ45
Spot (Aux) Out .....	4 BNC
Power .....	2.1mm pin type; female
P/S2 Mouse Port .....	1 5-pin mini DIN

**Front Panel Controls**

- Manual Alarm
- VCR
- Macro
  
- Panic Record
- Full
- PIP
- 2 x 2
- 3 x 3
- 4 x 4
- Sequence
- 2nd
- Freeze
- Zoom
- Set
- Esc
- Cameras 1 to 16
- Cursor (up, down, right, left)

**Power Requirements**

DC 12V  3A

**Power Adapter**

100 - 240V~, 50/60Hz

**Dimensions**

Unit Size ..... 17"W x 1.73"H x 12.2"D  
432W x 44H x 310D mm  
Shipping Size ..... 26"W x 4.8"H x 15.5"D  
660W x 123H x 393D mm

**Weight**

Unit Weight ..... 5.3 lbs (2.4 Kgs)  
Shipping Weight ..... 9.5 lbs (4.3 Kgs)

**Operating Environment**

Ambient Temperature ..... 32° to 95° F (0° to 35° C)  
Ambient Humidity ..... 10% to 90% non-condensing



**Honeywell Security  
Honeywell Video Systems**  
2700 Blankenbaker Parkway  
Louisville, KY 40299  
[www.honeywell.com](http://www.honeywell.com)  
1.800.796.CCTV

**Honeywell Security Australia Pty Ltd.**

Unit 5, Riverside Centre, 24-28 River Road West  
Parramatta, NSW 2150, Australia  
[www.ademco.com.au](http://www.ademco.com.au)  
TEL +61-2-8837-9300

**Honeywell Security Asia Pacific Ltd.**

Flat A, 16/F, CDW Building, 388 Castle Peak Road  
Tsuen Wan, N.T., Hong Kong  
[www.ademco.com.hk](http://www.ademco.com.hk)  
TEL +853-2405-2323

**Honeywell Security France**

Parc Gutenberg, 13, Voie La Cardon  
91120, Palaiseau, France  
[www.ademco.fr](http://www.ademco.fr)  
TEL +33-1-6932-1090

**Honeywell Security Italia SpA**

Via della Resistenza 53/59, 20090 Buccinasco  
Milan, Italy  
[www.ademco.it](http://www.ademco.it)  
TEL +39-02-457-1791

**Honeywell Security Espana**

Calle Vivero, 5, 28040  
Madrid, Spain  
[www.ademco.es](http://www.ademco.es)  
TEL +34-91-533-4706

**Honeywell Security House (Netherlands)**

Amperestraat 41  
1446 TR Purmerend, Netherlands  
[www.SecurityHouse.nl](http://www.SecurityHouse.nl)  
TEL +31-299-419-000

**Honeywell Video Systems UK Ltd.**

Aston Fields Road, Whitehouse Ind Est  
Runcorn, Cheshire, WA7 3DL, UK  
[www.videocontrols.co.uk](http://www.videocontrols.co.uk)  
TEL +44-1928-754-000

**Honeywell Security South Africa**

Unit 6 Galaxy Park, Galaxy Avenue, Linbro  
Business Park  
P.O. Box 59904, kengray, 2100, South Africa  
[www.honeywell.co.za](http://www.honeywell.co.za)  
TEL +27-11-574-2500

**Honeywell Security Germany**

Großenbaumer Weg 8  
40472 Düsseldorf, Germany  
[www.ultrak.com](http://www.ultrak.com)  
TEL +49-211-415-090

**Honeywell Security Poland**

Chmielewskiego 22a, 70-028  
Szczecin, Polska  
[www.ultrak.pl](http://www.ultrak.pl)  
TEL +48-91-485-40-60

**Honeywell Security Czech Republic**

Havránkova 33, Brno  
Dolní Heršpice, 619 00, Czech Republic  
[www.olympo.cz](http://www.olympo.cz)  
TEL +420-543-558-111

**Honeywell Security Slovakia Republic**

Vajnorská 142, 83104 Bratislava  
Slovakia  
[www.olympo.cz](http://www.olympo.cz)  
TEL +421-2-444-54-660

# Honeywell

Video Systems  
[www.honeywell.com](http://www.honeywell.com)  
1.800.796.CCTV

© 2005 Honeywell International Inc.

All rights reserved. No part of this publication may be reproduced by any means without written permission from Honeywell Video Systems. The information in this publication is believed to be accurate in all respects. However, Honeywell Video Systems cannot assume responsibility for any consequences resulting from the use thereof. The information contained herein is subject to change without notice. Revisions or new editions to this publication may be issued to incorporate such changes.